



SkyWind NG  
Next Generation Windpower

TRANSLATION OF THE ORIGINAL MANUAL

# Owners Manual SkyWind NG

Version 6.0 – 01.01.2025



## Legend for warning and safety instructions in this manual:

 **Danger to life and limb**

 **Risk of catastrophic technical failure**

 **Important technical information**

**FOR INSTALLATION BY TRAINED PROFESSIONALS ONLY!**

*see page 6 – Trained Professionals*

---

*This document represents the interpretation of the original document “Bedienungsanleitung, Version 6.0” which may be found online at <http://myskywind.com/> and was made to the best knowledge of the interpreter. Only the original document is legally binding.*

*Please always check for the latest document online at: [www.myskywind.com](http://www.myskywind.com)  
Manual is subject to change without notice. Only the latest version is binding.*



[www.myskywind.com/infothek](http://www.myskywind.com/infothek)

<b>1.</b>	<b>ANNOTATIONS</b> .....	<b>4</b>	<b>8.</b>	<b>INSTALLATION SITES FOR SKYWIND NG</b> .....	<b>26</b>
<b>2.1</b>	<b>INTRODUCTION</b> .....	<b>5</b>	8.1	Installation Site .....	26
2.2	Trained Professionals .....	6	8.2	Turbulence .....	27–28
<b>3.</b>	<b>DELIVERY CONTENTS</b> .....	<b>7</b>	8.3	Annual Yield .....	29
<b>4.</b>	<b>TARGET AUDIENCE AND USER ADVICE</b> .....	<b>8</b>	<b>9.</b>	<b>TOWERS</b> .....	<b>30</b>
4.1	Target Audience .....	8	9.1	Requirements for towers .....	30–31
4.2	User Advice .....	8	9.2	Structural stability .....	32–33
4.3	Appropriate Use .....	9	<b>10.</b>	<b>WIRING/ELECTRICAL INSTALLATION</b> .....	<b>34</b>
4.4	Mandatory: Log book .....	10	10.1	Wiring .....	34
<b>5.</b>	<b>SAFETY</b> .....	<b>11</b>	10.2	Grid Inverter .....	35
5.1	Mechanical Dangers .....	11	10.3	Setting up the inverter .....	36
5.2	Electrical Dangers .....	11	10.4	Correction for height above MSL/density altd. ....	37
5.3	Safety During Installation .....	12	10.5	Template and documentation obligation .....	38
5.4	Installation Guide .....	13	10.6	AC-wiring .....	39
5.5	Operating Instructions .....	14	10.7	Wire Cross-Section .....	40
<b>6.</b>	<b>TECHNICAL DATA</b> .....	<b>15</b>	10.8	Operating states of SkyWind NG .....	41
6.1	Specification SkyWind NG .....	15	<b>11.</b>	<b>WIRING DIAGRAM/STROM CONTROL</b> .....	<b>42</b>
6.2	Specification Grid Inverter (option) .....	16	11.1	Grid or AC-connected installation .....	42–43
6.3	Specification Charge Controller (option) .....	17	11.2	Battery charger or DC-installation .....	44–45
6.4	Advice to your wind generator .....	18–19	11.3	Setting up the storm control .....	46–47
<b>7.</b>	<b>INSTALLING THE SKYWIND NG</b> .....	<b>20</b>	<b>12.</b>	<b>OPTIONAL NOISE CONTROL</b> .....	<b>48</b>
7.1	Installation Schedule .....	20	<b>13.</b>	<b>INITIAL START-UP</b> .....	<b>49</b>
7.2	Fitting the cables to the generator .....	21	13.1	Electrical inspection and mechanical test .....	49–50
7.3	Preparations for installation .....	22	13.2	Fine adjustment/noise-reduced operation .....	50
7.4	Mounting the rotor blades .....	23–24	13.3	Documentation .....	51
7.5	Mounting the nacelle .....	24–25	<b>14.</b>	<b>FINAL NOTES</b> .....	<b>52</b>

All information provided in this document are deemed reliable. However the user of this information is liable for their use.

## Agreement on the legal and factual nature according to § 434 I 1 BGB:

Our SkyWind products are only suitable for installation and commissioning by trained professionals. The operating instructions and installation instructions must be followed. The specific product performance/characteristics depend on the version, the characteristic curve suitable for the site, which is set by the installation company, and the site quality. If necessary, official permits, approvals, tests, certificates or other regulations for assembly, installation, connection, activation or operation must be obtained or observed. The user is responsible for identifying the relevant regulations and for complying with them. SkyWind Energy does not assume any warranty for the issuance of the same. In particular, the refusal does not constitute a defect in the product. Problems or deficiencies can only be handled after a complete log book has been submitted. The purchaser acknowledges and agrees to these terms and conditions by entering into the purchase agreement.

All specification are subject to change without further notice. Only the latest version of this document is valid. Owner must check for relevant changes on safety related topics from time to time.

Wind generators – as other sources of energy – must be installed, activated and operated in accordance with national law and regulation. Buyer has informed on his national regulation and is solely responsible for compliance.

When necessary the SkyWind owner will obtain regulatory approvals as might be required by national law. The owner is solely responsible for identifying such laws and regulations and the compliance with such. Missing or declined allowances are not deemed defects or flaws on behalf of SkyWind Energy.

**Always attach your receipt to this manual and note down your products serial number.** You will need this information in case of warranty claims. You will also need your serial number in case of technical questions to the customers support.

## MANUFACTURED IN GERMANY BY:

SkyWind Energy GmbH  
Bayernstr. 3  
30855 Langenhagen  
Germany

Tel.: +49 (0)511 444 570 45  
Mail: [post@myskywind.com](mailto:post@myskywind.com)  
Web: [www.myskywind.com](http://www.myskywind.com)

© 2025 SkyWind Energy GmbH



Note your serial number here:



### CONGRATULATIONS!

You are now the owner of the most advanced micro wind turbine system! To maximize your energy yield and allow for a trouble free operation it is very important to fully read and understand the information provided within this document. You may update your older **SkyWind NG** micro wind turbine, manufactured by the SkyWind Energy GmbH, to the new version (2. Gen) by programming the power curve and storm control settings provided within this document on your wind turbine.

SkyWinds technology is based on more than ten years of ongoing development. Our rotor systems and certain key technologies are patented.

**SkyWind NG** wind turbines are set apart from other products by the use of latest manufacturing technologies while avoiding the use of neodymium magnets. SkyWinds all metal manufacturing guarantees for unmachted durability and operational life.

The **SkyWind NGs** electrical design is essential for ist performance and efficient operation with 230/110 V grids. Our complex and patented rotor was designed with the aid of both computational fluid dynamics and wind test field evaluations by world leading Windtest Grevenbroich GmbH and Windward Engineering of UT, USA.

Read and understand these information well to ensure a reliable and efficient operation of your wind turbine system for years to come.



**Your SkyWind NG micro wind turbine system must always be handled, installed, activated and operated by trained professionals (see Chapter 2.2)!**

*Under no circumstances should you ever try to work on your wind turbine on your own. Please check the agreement on the legal and factual nature of your product and order.*

*The contents of this manual in their entirety are mandatory for anybody working on the wind turbine system. The owner is liable for correct installation and operation of the system. Provisions made and tips provided in the trained professionals guide are only supplementary to the owners manual and do not replace it. The warranty is voided and SkyWind Energy GmbH is not liable for any damages if the owner of the product breaches the legal agreement according to §434 I 1 BGB (p. 4), or installs/operates the product not according to this manual.*

## 2.2 TRAINED PROFESSIONALS

**⚠ Your SkyWind NG is a wind turbine. Its installation and maintenance work must always be performed by trained professionals, as regulated by chapter 11.2.3.1 of DIN EN 61400-2, the purchase agreements and this manual.**

Under the provisions of this manual a trained professional is defined as:

### 1. A person with profound knowledge and training in the crafts required to install a small wind turbine. This includes:

- Craftsmen with professional experience in the required sector. For example:
  - A) Roofers/Carpenters/Solar Technician for the hardware installation
  - B) Electricians/Solar Technicians for the electrical installation and set-up
- Permit and qualification for installing AC-equipment in accordance with the regulations set forth by the law, as well as all local regulations and in-house instructions of the company.
- Knowledge of all accident prevention regulations.

Trained professionals are also instructed on all required safety equipment, standard procedures and emergency response. A “supervision” of the installation by a trained professional is not sufficient. All installations or maintenance must be performed by a trained professional.

### 2. A person familiar with this kind of equipment, its installation and operation, trained, qualified and entitled for work on this kind of electrical and mechanical equipment. Training for this small wind turbine must include at least:

- Reading and understanding all provisions, tips, background information and safety precautions regarding his work on the wind turbine as detailed in this product manual and the trained professionals guide.
- Familiarize with the actual hardware to set-up and the installation steps to be performed, before entering the construction site.

All work must be performed by trained professionals only. Otherwise warranty is void. SkyWind is not required to identify such professionals for the customer.

**For the avoidance of doubt it is declared that it is not necessary for any trained professional to be selected, approved or certificated by SkyWind Energy GmbH.**

The provisions set forth in this manual shall be deemed complied with if a trained professional can demonstrate that the requirements defined under section 1 and 2 of this page are met. Each person operating the turbine must have read and understood this manual.

### 3. DELIVERY CONTENTS

#### DELIVERY CONTENTS OF A SKYWIND NG (230/110 V)

- 1 2x Rotor Blade SkyWind, anti-reflective coating, grey (1x left/1x right)
- 2 Nacelle with anti-reflective coating, grey
- 2a Rotor mounting set, consisting of:  
Plate, Cone, Countercone, Lock Ring, Screw
- 2b Tower mounting adapter for 59 – 61 mm tower
- 3 Low-voltage DC-grid inverter, 1 kW
  - incl. LCD-colour display with backlight
  - customizable power curve and onboard computer
  - An AC-connection cable
- 3a DC-dumpload for automatic braking system
- 4 Automatic storm control system for **SkyWind NG**, Control unit, Time delay relay, High-current relay
- 5 Original manual and original log book (digital)



**Notice:** Any tower or tower system is never a part of the this wind turbine system but rather a separate system as specified by DIN EN 61400-2. SkyWind Energy does not manufacture tower systems but is reselling some systems of other manufacturers it has found to work well with the SkyWind NG wind turbine. However SkyWind Energy is not liable for correct

function of the wind turbine with certain tower systems or accessories. PLEASE CHECK YOUR DELIVERY FOR WHOLENESS AND INTACTNESS IMMEDIATLY UPON RECEIPT OF GOODS (3 days): LATER COMPLAINTS ARE NOT PERMISSIBLE. Further components not included in this set are required to perform a correct installation (see manual).

## 4. TARGET AUDIENCE AND USER ADVICE

### 4.1 TARGET AUDIENCE

- This manual is made for owners and trained professionals installing and operating the equipment. It must be known and considered by every person working on the wind turbine.
- Only trained and qualified personal is allowed to work on the wind turbine and equipment.
- Children or physically or mentally challenged persons must never approach the machine.
- Kids may not play with this machine or be allowed to approach it. All system and control components must be installed in such a position that children cannot reach them.

### 4.2 USER ADVICE

Any liability or warranty by SkyWind Energy is ruled out if it is caused by one or more of the following causes. Only SkyWinds warranty terms apply which may be downloaded from [www.myskywind.com](http://www.myskywind.com) (German language original):

- Usage not according to the intended purpose
- Disregard of this manual (either in parts or as a whole)
- Operation at unsuitable sites
- Missing documentation on set-up and installation, missing or incomplete log book
- Operation without properly working safety equipment

- Continued operation despite defects (on parts) of the machine or equipment
- Unqualified installation, activation, set-up, operation, maintenance etc.
- Changes to the system or its components
- Installation of additional parts or equipment not intended for use with this wind turbine
- Unqualified or incorrect repairs
- Installation of non-original parts
- Defects from outside (e.g. electricity grid over-voltages, defects etc.)
- Force majeure

 **This symbol indicates warnings and very important information. Violation can mean danger to life or even death. Observe all regulations strictly!**

### DISPOSAL

According to WEEE-Directive 2012/19/ EU on disposal of electric and electronic equipment this equipment must be collected separately and recycled after the end of its useful life. The owner is required to make sure that all regulations are strictly followed and a correct disposal is ensured. Owner must gather information on how to dispose the items correctly and follow these instructions.



### WEAR AND SERVICE LIFE

A wind turbine is a mechanical system that is subject to age-related and performance-related wear. It is therefore important to ensure safe operation over the operating period through inspection. A system that is damaged or not working properly must be taken out of operation immediately. If errors occur after the turbine is older than 20 years, repairs are not permitted and the system must be dismantled.

The system must be checked to be in perfect working condition by a trained professional (see operating instructions) every 5 years. In particular, the rotor and cable must be checked thoroughly for damage and the brake and switch-off must be checked for correct function. The tests must be documented in writing. Also renew the corrosion protection with spray wax.

 **Severe storm events can damage your system, for example by foreign objects hitting the rotor. After storms, check the system for perfect condition and correct operation. Sudden vibrations or visible damage require immediate repair of the system. Otherwise, a rotor can only be destroyed much later, for example due to previous damage. Document the storm and your examination.**



## 4. TARGET AUDIENCE AND USER ADVICE

### 4.3 APPROPRIATE USE

#### WIND TURBINE

A wind turbine consists of the following, appropriately installed and set-up, components:

- a low voltage DC-grid inverter, 1kW with Dumpload by SkyWind Energy or a 12/24 V DC, 30 A charge controller by SkyWind Energy
- a SkyWind wind generator nacelle
- a Skywind two-blade rotor (left and right half)
- a storm control/braking system by SkyWind Energy

#### WIND TURBINE GRID INVERTER

The **SkyWind NG** grid inverter is solely intended to convert the DC-power generated by a single wind turbine into useful 110/230 V AC-power and to control the wind turbine. Not appropriate use is considered:

- any kind of use not mentioned above (e.g. use with solar systems etc.)
- modifications to the inverter
- installation of new parts into the inverter or its components

#### 12/24 V DC-CHARGE CONTROLLER

The SkyWind battery charger is intended solely to charge 12/24 V lead type batteries with the power of a single wind turbine. Not appropriate use is considered:

- any kind of use not mentioned above (e.g. use with solar systems etc.)
- modifications to the inverter
- installation of new parts into the inverter or its components

#### TWO BLADED ALL-METAL ROTOR

The **SkyWind NG** rotor blade is intended for use with the **SkyWind NG** nacelle and generator only. Never and under no circumstances may it be installed to other generators or nacelles. The rotor blade is to be mounted with the winglets facing away from the generator and nacelle.

- Never use not original parts for your SkyWind turbine!
- Never use damaged parts, Always check for a properly installed turbine first
- Force majeure is excluded from warranty
- Wind turbines and especially rotor blades are wear parts: Wear damage and force majeure is excluded from warranty.

#### STORM CONTROL SYSTEM

The control unit, time delay relay and high power relay must be installed and set-up correctly! Mounting a rotor to the wind turbine without installing a functioning storm control system first is not allowed and extremely dangerous!

#### SOUND LIMITING SYSTEM

The wind speed sensor of the sound control system must be installed within 1 m (3 ft) of the wind turbines nacelle.

The wind sensor must be placed in free flow of the wind and not be disturbed by walls, towers or the wind turbines rotor.

The wiring and set-up of the control unit is to be installed according to specification. A too long cable may harm the correct transmission of data and signals.

#### ISLAND PROTECTION/VDE 4105

The overall installation may have to comply with national requirements for a grid-parallel installation. If necessary, external NS-protection or a electrical equipment may be required to connect the wind turbine to the power grid. This equipment can, for example, implement individual frequency/voltage specifications.

Be sure to follow the safety instructions and assembly instructions in the latest operating instructions for the device you are using. The operator is responsible for compliance with all relevant regulations.

## 4. TARGET AUDIENCE AND USER ADVICE

### 4.4 MANDATORY: LOG BOOK (!)

**According to DIN EN 61400-2 paragraph 11.2.5.3 and the manufacturer's specification, a log book is mandatory for each Skywind NG wind turbine. The original log book is included in the scope of delivery of your wind turbine and is assigned to it by a code. Therefore you must always keep the log book together with your wind turbine.**

The log book accompanies your personal **SkyWind NG** from its first to the last day. It is the detailed profile of your wind turbine. Your trained professionals will record the assembly and commissioning tests, store photos of the turbine and the surrounding area, inspections and all special events in it. Static calculations, circuit diagrams or other documents are attached to the log book as an appendix.

Think of it like your car's registration document and checkbook. The log book must be maintained in such a way that it allows to understand all specifics of your turbine, site, installation and maintenance work, many years after its installation. If a wind turbine is uninstalled in order to be reinstalled elsewhere, you also start a new log book with the new installation, of which the old log book becomes an attachment. You can only get a new logbook on a written request from Skywind Energy GmbH. The new log book will then be assigned to your system.

In case of any questions or problems with your turbine, our service can help you quickly and substantiated with the information contained in your log book only. Please note that the correct and complete maintenance of the log book is within the risk of the system purchaser. Always keep it up to date.

#### NOTE:

*The log book is part of your wind turbine. Your wind turbine is not complete without a log book. If your system is sold or passed on otherwise, the log book must always be presented. In the event of a warranty or warranty case, you are obliged to present your fully and correctly maintained log book. An incomplete or non-existent log book is a serious deficiency voiding your warranty.*

 Only use the log book delivered with your turbine.

 Make sure that all trained professionals document their work on the turbine in your log book.

 **A missing log book will void the warranty on your wind turbine.**

 **There is no such thing as a "test installation". Every installation must be performed to fulfill all provisions of this manual and must be fully documented in the turbines log book.**

 Note every work performed on your wind turbine immediately and correctly.

 Plagiarized turbines, looking just like a SkyWind NG, may be found online. These turbines are not made to our specification and may be very dangerous to operate. Make sure you are only operating original hardware! Please inform SkyWind Energy GmbH on illegal product copies.

## 5. SAFETY

The **SkyWind NG** wind turbine was developed with your safety in mind. But, since it is an electrical and mechanical appliance certain dangers are related with its use. Only trained professionals are allowed to work on the system.

Safety must be the most important concern when planning and installing your wind turbine system. You must always be aware of the dangers of the machine and electrical systems. Unqualified handling may result in mechanical damage, serious injury or even death.

### 5.1 MECHANICAL DANGERS

Rotating parts, like the rotor blades of your **SkyWind NG** micro wind turbine represent the most obvious but also the most dangerous mechanical part. The rotor blades are made from light aerospace grade aluminum with the blade tips rotating at up to 400 kph (250 mph). At this speed the rotor blade is almost invisible to the human eye and can cause very serious injuries. Never should the turbine be installed in a place where it is possible for a person to reach into the rotor blades during normal operation. The turbine should also be situated in a place where a damaged blade (e.g. by force majeure) can not harm people.

During installation the weight of the nacelle should not be underestimated. Be cautious: The center of gravity of the turbines nacelle is not at the mast adapter.

### 5.2 ELECTRICAL DANGERS

Electrical current is always dangerous and every line can be a live wire. Always be careful!

Heat in electrical connections is often the result of too much current in lines with too little diameter. Always make sure to use a sufficient wire diameter. Keep an eye on cable-joints which can also cause resistance and thus heat. The wind turbine must always be connected with 6 mm<sup>2</sup> Solarflex®-X (HELUKABEL) wire.

Within this manual you might find safety precautions which all have to be considered equally important, regardless of their actual position within the document. It is within your own best interest to read the complete document before starting your work.

### DANGERS OF BATTERIES

Batteries can store large and potentially hazardous amounts of energy which can be delivered within a very short amount of time. If batteries are included in an electrical system the risk of fire in case of short circuits etc. are much higher. Install a fuse to your battery connection to prevent this risk. Also make sure to connect the battery as a last step after all the wiring and connections have been finished. Never use damaged parts and make sure to look for maintenance that might be required for your battery type.

 **The exactly vertical alignment of the tower, the exactly vertical position of the nacelle on the tower, the perfectly balanced installation of rotor blades, the correct torque for the rotor screws and the correct set-up of storm control and inverter is vital for successful operation. Failure to do so may lead to damage or even destruction of the turbine.**

 **Do not install the turbine in a place where people might be able to reach into the rotor.**

 **Always fix the rotor blade (tie it to the tower) before working on the turbine or the electrical system and cables.**

 **Use sufficient cable diameters. Within the tower and the turbine only 6 mm<sup>2</sup> Solarflex®-X cable (HELUKABEL) or comparable is allowed.**

## 5. SAFETY

### 5.3 SAFETY DURING INSTALLATION

Please take at least the following precautions during your installation:

- Choose a calm day. No more than 2 Bft of wind is allowed!
- **KEEP YOUR SAFETY IN MIND!** Contract trained professionals for the installation.
- Disconnect any power sources (Public grid, batteries, storages of all kinds) from your wind turbine and its electrical components (charge controller, grid inverter) during installation.
- Make sure that the wind turbines cables (red/black +/-) are shorted during installation of the rotor blade. This will prevent the turbine from rotation.
- Keep in mind that this is a mechanical piece of equipment that might generate large amounts of physical force as the wind, especially during a storm, can create sudden bursts of immense power. It is important to take all installation steps with care for detail and to check every step once work is completed. Very little power production or even a broken turbine are the likely result of mistakes. A wind turbine can be destroyed by a single gust within literally seconds if handled or installed incorrectly.

We wish you a successful and long lasting operation of your SkyWind NG turbine!

 **Install a fuse for the AC-Output of your wind turbine system. Never install a fuse between the turbine and the grid inverter or charge controller.**

 **NEVER work on a live wire. Always disconnect or shut down all power sources before starting work.**

 **Always contract trained professionals for the installation or work on the turbine!**

 **Prepare as much as you can while on the ground. Reduce the time and work on the rooftop or tower as much as you possibly can.**

 **Always make sure the turbine is shut-off when working on the system – no matter which part you are working on.**

 **Make sure the rotors have the correct orientation: The winglets must face away from the nacelle.**

 **Installing the rotor blades must be the very last step of the installation. Only install the rotor once every other step is finished.**

## 5. SAFETY

### 5.4 INSTALLATION GUIDE

**Make yourself familiar with all safety precautions.**

**Check that all components you will need are on-hand:**

- **SkyWind NG** wind turbine (p. 7)
- Inverter with accessories (p. 7)
- Automatic storm control system (p. 7)
- Min. 10 m 6 mm<sup>2</sup> Solarflex®-X cable per turbine (p. 40)
- Tower with correct length/wall/diameter (p. 30–33)
- Protective wax coating (e.g. Art.-Nr. 6103)
- If needed: Additional AC-accessories (Fuses, VDE 4105 etc.)

**Plan your installation ahead and keep everything you need at hand!**

- Install the tower and, if required, noise decouplers and align it **perfectly vertical**.
- Install the grid inverter **and program the correct settings** (p. 36–38).

- Install the storm protection system and set the main switch in OFF (p. 42–47).
- Prepare the turbines nacelle and install the cables (p. 21).
- Put the cable into the tower and install the nacelle perfectly vertical (p. 24).
- Apply the protective wax coating to the nacelle
- Only now install the rotor blades to the nacelle and **align them exactly** (p. 49–51).
- Check and test your installation thoroughly (p. 21).
- Prepare the documentation with pictures and details!

*This summary is to provide you with an overview of the general order the steps are to be taken. The installation must be performed by trained professionals!*



Stand-alone installation on a tower



Flange-mounted to a flat roof building



Mounted on a standard rooftop

## 5. SAFETY

### 5.5 OPERATING INSTRUCTIONS

Check the turbine regularly on an annual basis, for any kind of visual or obvious damage to the rotor, the nacelle, the tower, the electric components. The rotor blades are very durable – however they can deform when hitting a solid object (flying tree branches, birds, debris). The turbine can also be damaged by vibration within the tower which can lead to fatigue damage or even destruction of the turbine.

Always make sure to switch the turbine's main switch to "OFF" while performing maintenance works or accessing areas near the turbine. This must stop the turbine's rotation and power generation immediately.

Within the first weeks after installation you must check the tower for any signs of vibration during operation. If the turbine's tower has not been chosen correctly the system must be changed – for example you may add guy wires to stiffen the tower. A wrong tower can cause damage to your turbine a very short amount of time.

Choose a calm day for any kind of work or inspection on the turbine **(max. 2 Bft!)**

**A safe and efficient operation for years to come is only possible with a correctly installed and set-up wind turbine on a suitable site.** If your wind turbine is not installed correctly the result may be little power generation or even damage to the turbine within short time.

**Document your installation and settings with pictures!** You may only file a warranty claim if you can prove that the turbine has been correctly installed and set-up. Did you choose the correct power curve? Was the storm control set-up correctly? Be prepared to answer these questions with pictures showing the setting and the date. SkyWind Energy will only warrant for correctly installed and set-up wind turbines.

---

**⚠ SkyWind NG 230/110 V will need a stable and consistent grid supply. Frequent power shortages or grid failures may cause damage to your wind turbine or inverter.**

**⚠ Check your wind turbine for mechanical integrity after a storm. Immediately shut off the turbine in case of any damage. Only restart operation after professional repairs have been finished.**

**⚠ Always document your work with pictures, videos and written notices. Only a fully documented installation will receive warranty.**

**⚠ Apply underbody protection wax (spray can for cars) to the complete nacelle once the installation is finished. Look for contact areas, screws or areas with minor damages to the coating that might have been caused during the installation process. Cover the entire nacelle (not the rotor!) with a thick protective wax coating.**

**i A new wind turbine will require some 10 to 50 operating hours at normal windspeeds (8 – 9 m/s) before they start-up normally. During these first few hours the start-up windspeed might be increased and the wind turbine might start power generation a bit later than usual.**

---

**⚠ Never approach the turbine while it is operating. Be careful!**

---

## 6. TECHNICAL DATA

### 6.1 SPECIFICATION SKYWIND NG

<b>Model</b>	SkyWind NG (incl. 2. Gen)
<b>Maximum Power</b>	600   800   1000 Watt (AC) or 30 A (DC)
<b>Tested to</b>	ANSI/ACP 101-1:2021 with IEC 61400-2
<b>Weight</b>	Ca. 19 kg
<b>Rotor Diameter</b>	1,50 m
<b>Swept Area</b>	1,77 m <sup>2</sup>
<b>Type</b>	HAWT, Downwind
<b>Rotor Blades</b>	3 mm Aluminium, Anti-Reflective Coating
<b>Operational rpm</b>	300– 1500 rpm
<b>Generator</b>	Gearless PMG, C8 Ceramic
<b>Internal Resistance</b>	1,1 Ohm
<b>Operational Voltage</b>	Min. 15 V, Max. 40 V DC
<b>Maximum Ampere</b>	30 A
<b>Short Circuit Amp. (&lt;10 s)</b>	45 A
<b>Survival Wind Speed</b>	Ca. 40 m/s
<b>Own consumption</b>	<10 W (incl. storm control system)
<b>Grid Inverter (Optional)</b>	Included 1 kW, Wind Turbine Inverter
<b>Battery Charger (Optional)</b>	Included 30 A (12/24 V) Charge Controller
<b>Brake</b>	Eddy Current, Stall
<b>Maximum Thrust On Tower</b>	250 N
<b>RRP</b>	2.478,15 € excl. VAT

**SkyWind NG Micro Wind Turbine**  
Set to 600 W

Manufacturer:  
SkyWind Energy GmbH

Model:  
SkyWind NG Micro Wind Turbine

Test Report No.:  
PP Test Report-SkyWind\_26July2024\_vf1.5\_DAD\_pg117



**Rated Annual Energy**

The calculated total energy, expressed as kWh, that would be produced during a one-year period at an average wind speed of 6 m/s (13.4 mph), assuming a Rayleigh wind speed distribution, 100% availability, and the power curve derived from IEC 61400-12-1 ed. 2. Within this standard Reference Annual Energy is AEP-measured and sea-level normalized.

615

kWh/year

**Reference Power**

The wind turbine's power output, expressed as kW, at 11 m/s (24.6 mph), or the maximum output power of the wind turbine system at a lower wind speed if this is a higher power output, per the power curve from IEC 61400-12-1 ed.21, except as modified in Section 2 of this standard.

0,3

kW

**Peak Power**

Highest bin-averaged power output of all filled wind speed bins per the procedure defined in Section 4 Safety and Function expressed as [Peak Power] kW @ [Peak Power Wind Speed] m/s.

0,6

kW @ 15,9 m/s

Tested in conformance with

ANSI/ACP 101-1 2021 in conjunction with DIN EN 61400-12-1

For test summary report visit manufacturers website  
[www.myskywind.com](http://www.myskywind.com)

## 6. TECHNICAL DATA

### 6.2 SPECIFICATION GRID INVERTER (OPTION)

<b>Model</b>	TEG-1000G-WDL
<b>Max. Continuous Power</b>	900 W
<b>Max. Power AC</b>	1.000 W
<b>AC-Voltage</b>	185–265 V   95–140 V (Grid dependent)
<b>AC Frequency Range</b>	46–65 Hz
<b>THD</b>	<5 %
<b>Power Factor</b>	0,99
<b>Max. Efficiency</b>	92 %
<b>Output</b>	Pure Sine Wave
<b>Brake</b>	Dumpload and controller (included in delivery)
<b>DC-Input</b>	22–65 V
<b>Brake Controller</b>	Internal computer
<b>Power curve computer</b>	Yes
<b>Over Amp. Protection</b>	Yes
<b>Over Voltage Detection</b>	Yes
<b>Overheating Protection</b>	Yes (incl. active cooling)
<b>Island Protection</b>	Yes
<b>Level Of Protection</b>	IP 20
<b>Conformity</b>	VDE AR N 4105:2018-11 VDE V 0124-100:2020-06   VDE 0126-1-1

<b>Storage Temperature</b>	-40 °C to +65 °C
<b>Operating Temperature</b>	-20 °C to +50 °C
<b>Humidity</b>	Non condensating
<b>Displayfunction</b>	Power, Yield, Grid + Programming Interface
<b>Size</b>	350 x 195 x 90 mm
<b>Weight</b>	4,9 kg





## 6. TECHNICAL DATA

### 6.3 SPECIFICATION CHARGE CONTROLLER (OPTION)

<b>Model</b>	MPPT 30 A
<b>Max. Continuous Power</b>	360/720 W (12/24 V DC)
<b>Brake</b>	SkyWind NG Storm Protection
<b>Max. DC-Input</b>	60 V
<b>MPPT</b>	Yes
<b>Max. Ampere</b>	30 A
<b>Consumption (active)</b>	15 mA (130 mA with load activated)
<b>Consumption (standby)</b>	<0,1 mA
<b>Fuse</b>	30 A
<b>Reverse Polarity Prot. Batt.</b>	Yes
<b>Reverse Polarity Prot. Windt.</b>	Yes
<b>Overheating Protection</b>	Yes
<b>Temperature Regulated</b>	Yes
<b>Step-Up Function</b>	Yes
<b>Impulse Charging (Desulfation)</b>	Yes
<b>Operating Temperature</b>	-25 °C to +60 °C
<b>Common Ground (-)</b>	Yes
<b>Activatable Load Port</b>	Yes
<b>Case</b>	Metal
<b>Level Of Protection</b>	IP 20

<b>End-Of-Charge Voltage</b>	14,1 V / 28,2 V
<b>Float Charging Voltage</b>	13,7 V / 27,4 V
<b>Humidity</b>	Non condensating
<b>Cutoff Voltage</b>	10,5 V / 21,0 V
<b>Reset Voltage</b>	12,5 V / 25,0 V
<b>Battery Type</b>	Lead-Acid/Lead-Gel (AGM)



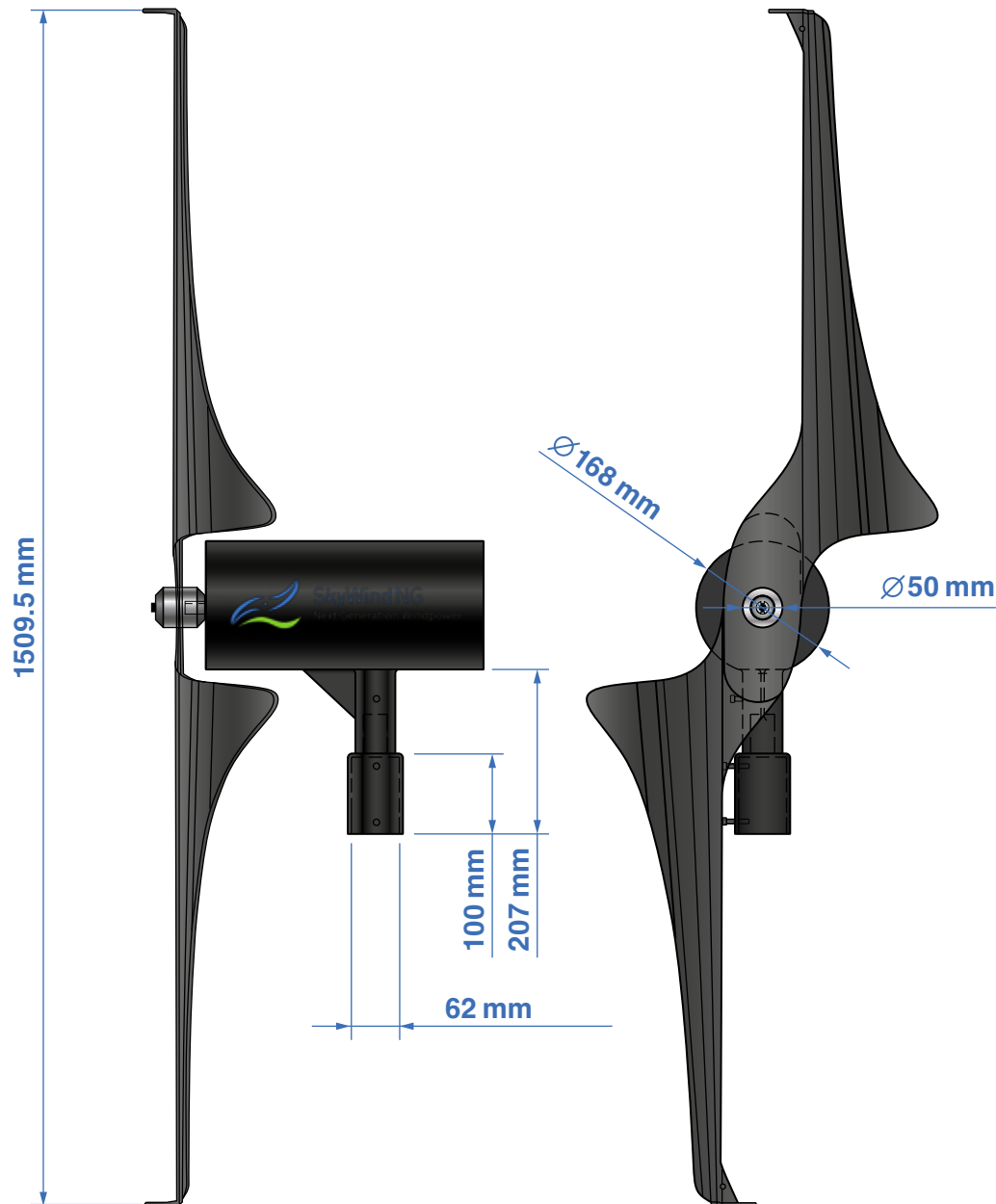

### 6.4 ADVICE TO YOUR WIND GENERATOR

Your trained professional will manufacture and commission a wind energy converter using the SkyWind NG components. The SkyWind NG itself is not a complete wind generator, further parts will be needed. These parts differ from site to site, project to project and intended purpose to intended purpose and include major parts like a suitable tower, foundation etc.

Usually at least the following additional parts and equipment will be needed:

1. A suitable tower, possibly with foundation and/or dampers for noise/vibration.
2. Cables, Zipties, Cable Joints, Screws etc.
3. Loctite® 243 (Henkel) glue.
4. Various small components such as connectors, fuses, residual current circuit breakers, mains filters etc.
5. Spray can of underbody protection wax for cars.
6. You will also need at least the following tools and equipment (see next page):

## 6. TECHNICAL DATA

---

- Torque handle 2/15 Nm
- Digital machine spirit level (accuracy 0,05°)
- Crimp tool
- Camera with date display in picture (for documentation)
- Regulated power supply (0–25 V DC, 0–5 A) for mandatory tests
- Grease

**Within this manual you will be guided through all important aspects of the successful installation of your wind energy converter.**

---

 **Important: Your rotor blades are balanced with each other. You must never separate the two blades of your rotor! If you have several SkyWinds or replacement rotors in stock, note the sets with clearly visible, written labels. The weights of different rotor sets can differ significantly, but the maximum permissible weight difference between the two blades of a set is 12.5 grams. Rotors with greater deviations may not be installed!**

---

### 7.1 INSTALLATION SCHEDULE

We have prepared this schedule to allow you to follow the steps undertaken by your trained professional. Always remember to document every step with pictures and detailed information.

1. Unboxing your **SkyWind NG**, check that everything is complete! *Check page five to see the delivery contents. Perform generator check (p. 56).*
2. Install the tower for your wind turbine. Align it **EXACTLY vertical!**
3. Cut the DC-cables to the correct length.
4. Open the nacelle.
5. Fit the cables through the mast adapter into the nacelle. Do not loosen the generator for this.
6. Connect the generator output cables with Crimp connectors to the cables.
7. Close the nacelle and tighten the screws (2 Nm) using Loctite® 243.
8. Install the inverter and do the wiring. **Set the required power curve as required for your installation site. Remember documenting.**

9. Fit the cables into the tower and mount the generator nacelle on top of the tower.

10. Tighten the mounting screws on the mast adapter and align the turbines nacelle perfectly vertical on the tower (see chapter 7.5).

11. Install the storm control system and **program the brake controller**. Check the wiring and remember the documentation. Set the main switch to OFF.

12. Check that the turbine and all components are fitted in the correct place and all screws are tightened as they should.

Check that the wind turbine can follow the wind direction freely (after turning it in one direction it must not turn back on its own).

13. Finish up the electrical installation and install accessories (if needed). Recheck that everything is set-up correctly.

14. Now install the rotor blade by following these steps (see details later):

- a. Slide the plate on the generator shaft
- b. Slide the aft cone to the generator shaft. Small side facing the generator.

c. Fit the two rotor blades on top of each other and align them.

d. Fit the front cone to the generator shaft. Large side facing the rotor blades.

e. **Align the blades exactly balanced** (p. 23).

The winglets (bended rotor tips) must face away from the nacelle. Glue all parts in place by applying plenty of Loctite® 243 between them and on the shaft!

15. Tighten the main mounting screw with **15 Nm** and secure it using Loctite® 243.

16. Apply the protective wax coating (underbody coating wax for cars) on the entire outside of the wind turbines nacelle.

17. Switch the turbine ON and perform final testing.

## 7. INSTALLING THE SKYWIND NG

### 7.2 FITTING THE CABLES TO THE GENERATOR

Feed the cables from the underside of the mast adapter into the nacelle (see picture). Guide one cable to the left of the main generator mount, the other to the right (see picture). **DO NOT DISMOUNT THE GENERATOR**, this will void your warranty.

Feed about 30 cm (1 ft) of cable (B) into the nacelle (A). Now tighten the cables using four zip-ties (C) which are fed through the holes provided in the generator mount.

Now permanently connect the ends of the output cables of the generator (2x ca. 0.75 mm<sup>2</sup>) with your 6 mm<sup>2</sup> cable. Use CRIMP connection with shrink tubing for isolation (**Sample: DSG Canusa, Art. Nr. 7931300102**)

By firmly tightening the zip-ties the connection is secured from the weight of the cable hanging inside the tower. The nacelle can also turn into the wind without harming the connection. The cable will prevent the turbine from turning too far, which is why it has to be solar cable. A slipping used in other turbine designs would only provide a lifetime of two years and is not needed for a down-wind turbine design.

**Please grease up the part where the cables are exiting the mast adapter into the nacelle. This further prevent wear on the cables.**

Use Loctite® 243 for all screw connections on the turbine to prevent unwanted loosening during operation. Be careful to not damage the turbines coating while working on the turbine. Should the turbine be damaged (or is to be installed on very salty places) apply the wax coating to the inside of the nacelle as well.

Always plan to use enough cable to get from the generator, through and out the tower in one piece. **The cable must not have any connections within the tower!**

**⚠ Use one uninterrupted cable from the nacelle to the inverter.**

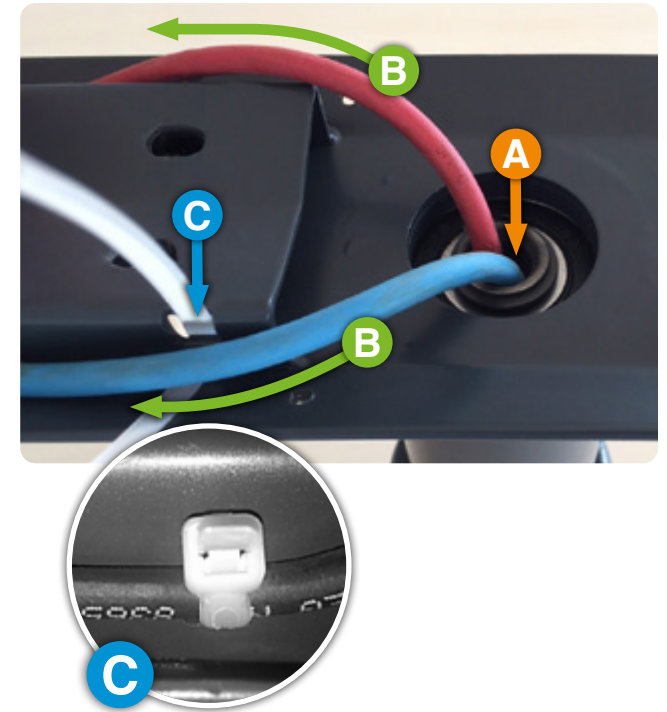

Only for illustration. **Do NOT remove generator.**

### 7.3 PREPARATIONS FOR INSTALLATION

- Perform the initial pre-installation checks as specified on page 56. A turbine that fails these tests must not be installed.
- **NEVER USE OTHER SCREWS AND COMPONENTS THAN THOSE INCLUDED IN YOUR DELIVERY!** Only place the turbine as shown in the picture below to prevent damage.



Place the system at an angle as shown!

- Feed the cables into the nacelle as described before and shown in the picture to the right. Remember to grease up the tower contact point (see picture last page). Never and under no circumstances may the generator be dismantled.

- Should you find screws of the generator to be loose reinstall them using Loctite® 243.
- At very corrosive sites (near coasts or on islands) please apply a wax coating to the inside of the nacelle as well. The coating must cover all parts of the nacelle.
- **Remount the nacelle cover by tightening all screws to 2 Nm using Loctite® 243.** Be exact and make sure every screw is correctly and firmly fitted (1 – yellow).
- The installation helper screw (4 – red) can block the rotation of the nacelle during installation. Make sure it is screwed in only half way and glued in with Loctite® 243 when your installation is finished to allow free rotation during later operation of the turbine.
- Spin the lower part of the mast adapter and try to vibrate a little, if you can't – everything is alright. Should the adapter not turn freely loosen the green locking screws a little and glue them in place using Loctite® 243. Should you be able to vibrate the mast adapter tighten the green (2) screws just a little so that the vibration disappears but you can still turn it freely. Then fix the screws using Loctite® 243.

- While mounting the nacelle to the tower you will fix the two orange (3) mounting screws using Loctite® 243. Make sure to tighten these **perfectly even** and check that the turbine is sitting **perfectly vertical** on the tower. The turbine will not work if the nacelle is misaligned from the vertical or shake/rattle violently.

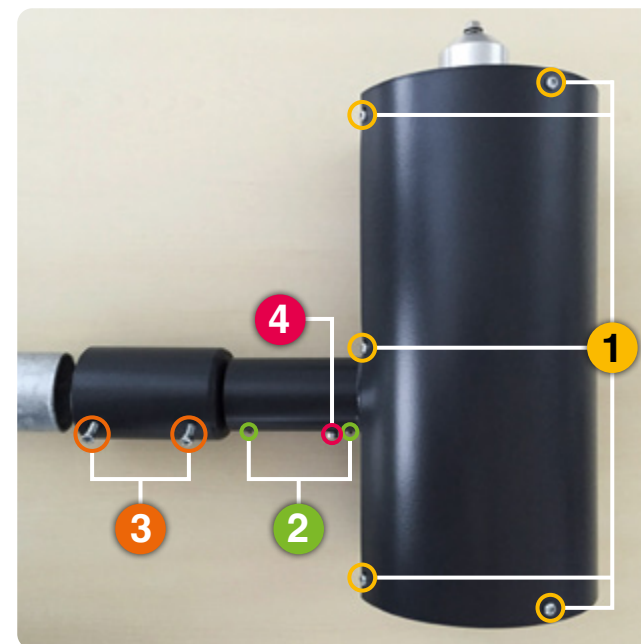

## 7. INSTALLING THE SKYWIND NG

### 7.4 MOUNTING THE ROTOR BLADES

(CAUTION: ACCURACY)

The **SkyWind NG** patented rotor blades are CNC cut from aerospace grade aluminum to an accuracy of 1/100 of a Millimeter. **Make sure to align the rotor blades perfectly one above the other.** Failing to do this step correctly will lead to constant vibration in your turbine!



Make sure to align the edges of the rotor blades perfectly on top of each other! Be very precise!

Although the blades are cut perfectly, the anti-reflective and noise reducing coat can affect the perfect fit on the shaft. You need to carefully remove the coating from the inside of the shaft mounting hole using a sharp knife.

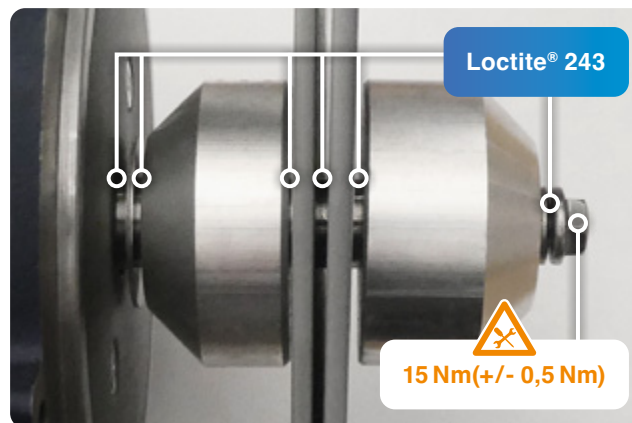

Use the correct order when installing the parts of the rotor blade. Be very precise!

Be aware that the central mounting screw is the only part holding the rotor assembly together. **Carefully** tighten the screw to **15 Nm (+/- 0,5 Nm)**, then remove the screw again. Now apply Loctite® 243 and carefully tighten the screw to **15 Nm** again! **Make sure the blades are perfectly balanced after tightening the screw. Take your time and make it perfect!**

Use plenty of Loctite® Type 243 glue on the screw and on **ALL** contact surfaces between the two cones and between the rotor blades and on the shaft! Make sure that the rotor blades do not twist when tightening and that they are still **EXACTLY** on top of each other after tightening! Take your time for a perfect result! Wait for the glue to dry before any operation. Don't install in the rain!

The **SkyWind NG** is a downwind, horizontal axis, micro wind turbine. This means the wind is coming 'from behind' of the wind turbine, passing along the nacelle and tower before hitting the rotor blade. This design allows the rotor adjust itself perfectly with changing wind directions – without a large and heavy wind vane or expensive yaw motors.

For a correct function the bended edges of the rotor blade, the winglets, must face with the wind – meaning away from the nacelle (p. 18). A rotor facing the wrong direction will not generate any power at all! If you should ever have to change rotor blades always renew both!

Looking at the wind turbine (rotor in front of the tower) the rotor must turn clockwise.

**After installation make sure that the rotor is firmly in place, spins absolutely freely and the nacelle can also turn 360° without any problems.** The nacelle must not turn back into one direction after being turned into any direction by hand – otherwise the tower is misaligned from the vertical position into the direction the wind turbine is leaning into.

Please note the instructions on the next page!



**⚠** Its not enough to just put the rotor blades on the shaft. The blades must be aligned perfectly balanced! Take your time!

**⚠** **ATTENTION:** You will need correct DIN tools to install the wind turbine. You will also need Loctite® 243 screw glue.

**⚠** Installing the rotor blade is the very last step. Make sure everything else is finished before and the turbine is set to OFF. Only use the exact two blades delivered with the turbine (p. 19)!

**⚠** NEVER may water, grease, wax or anything else be allowed to get between the rotor blades and the mounting parts during installation! Choose dry weather for installation!

**⚠** Important: Your rotor blades are balanced with each other. You must never separate the two blades of your rotor! If you have several SkyWinds or replacement rotors in stock, note the sets with clearly visible, written labels. The weights of different rotor sets can differ significantly, but the maximum permissible weight difference between the two blades of a set is 12.5 grams. Rotors with greater deviations may not be installed!

### 7.5 MOUNTING THE NACELLE (CAUTION: ACCURACY)

In addition to the exact assembly of the rotor blades, the correct assembly of the nacelle is also important for smooth operation. For exact alignment, you need a digital machine spirit level.

First of all, keep in mind the goal of your assembly work: When the nacelle rotates on the mast according to the wind, it must not turn back into a certain “preferred direction” by itself. Therefore, test at the end of the assembly, preferably in steps of 45° each, that you can turn the turbine into any position – without it turning back on its own.

If this does not work right away, performing one or more of the following steps will help:

1. Loosen the nacelle fixing screws once again and make sure that they are tightened exactly evenly. Uneven tightening will cause problems!
2. Loosen the nacelle fixing screws once again and turn the mast adapter 45° or 90°. Then tighten the screws evenly again.
3. Have a colleague lift the nacelle approx. 5 mm. Now fix the nacelle fixation screws evenly.

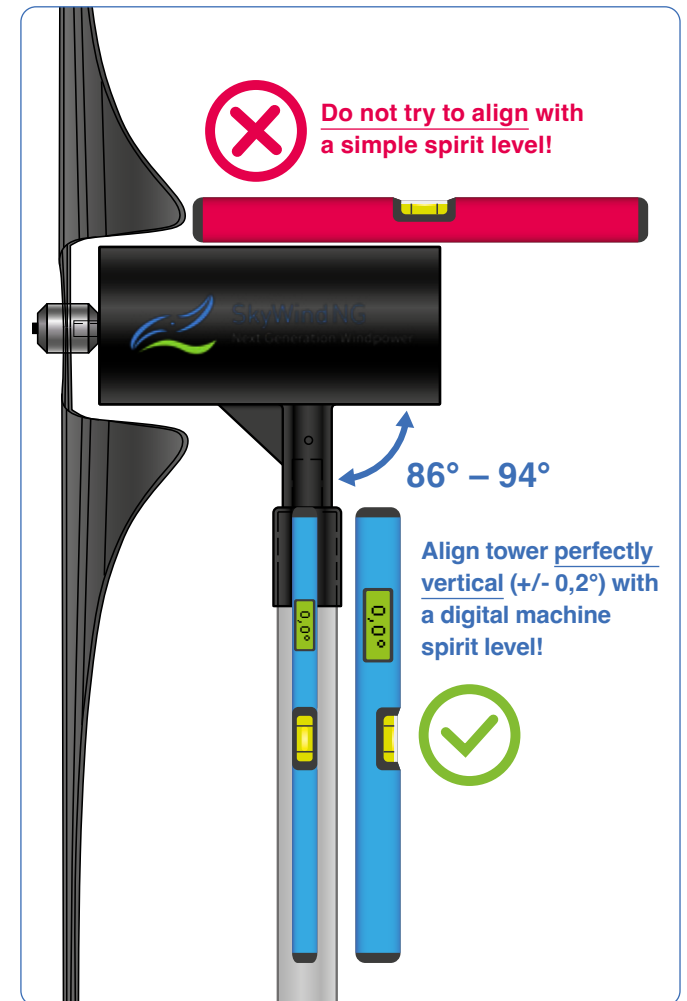

Please note the instructions on the next page!







## 7. INSTALLING THE SKYWIND NG

These steps, or a combination of these steps, may be necessary because the coatings (e.g. hotdip galvanizing and powder coating) and machining required on the components may not be exactly uniform. However, by following the above steps you will always find the correct position.

**ATTENTION:** The system will not work until you can turn the nacelle in any direction without it turning back to a certain “preferred direction” by itself. A not perfectly vertical assembly leads to sometimes very strong vibrations with frequencies of twice the rotor rpm – a continued operation can destroy the system very soon. Therefore, make sure that the nacelle can rotate freely and easily in any wind direction after installation.

 **Do not under any circumstances attempt to align the nacelle by tightening the bearing locking screws. This will lead to the immediate destruction of your wind turbine!**

 **Under no circumstances should you attempt to ‘align’ the nacelle with the nacelle mounting screws on the mast adapter. The two screws (see chapter 7.3) are exclusively intended for the tight connection of the two components (mast and nacelle)!**

 **Please note that it is not possible to simply place the nacelle ‘in the water’ with a spirit level on the nacelle top!**

 **Aluminum blades can be damaged during shipment or by harsh handling. Damaged blades may NEVER be installed on a wind turbine!**

## 8. INSTALLATION SITES FOR SKYWIND NG

### 8.1 INSTALLATION SITE

Anywhere on earth the wind speed increases with every meter height above the ground. This is caused by the friction of the wind on the earth's surface, trees, houses etc. This friction also causes turbulence and uneven wind flow. This in turn reduces the amount of energy a wind turbine can generate drastically. You should always install the **SkyWind NG** turbine at the place with the best (free) wind flow.

**Wind energy is a cubic function of wind speed.** In turn a small change in wind speed can have a large effect on the energy generation. For this reason a wind turbine must NEVER be installed below 10 m hub height. A turbine in 6 m hub height will often generate about 80% less energy than a turbine in 10 m and decrease its lifetime by more than 90%. **Under 10 m the wind turbine can not be expected to generate serious amounts of energy.** The wind turbine must also be higher than surrounding buildings or trees. Turbulent sites can not only reduce your energy yield, but also shorten the turbine's life as the turbulence creates harmful vibration. Make sure to choose a suitable site for your turbine!

#### Turbulent Sites

Imagine turbulence like a bumpy road, and your wind turbine as a car. A few miles of bad road, a few potholes – that's nothing to worry about. Maybe you slow down a bit, but generally your car is made for

that. However, things change if every road, even the highway, is full of potholes. In this case a new car will be wrecked in no time. It's just the same for your wind turbine. Stormy weather and wind gusts every now and then – no problem: your turbine is made for that. But if your turbine shakes and swings around all the time, even in generally steady winds, then even the best turbine will not last very long.

If the rotor is installed correctly, it will run smoothly and quietly during the commissioning test run. A rotor imbalance, for example due to incorrect assembly, would immediately become apparent here. So if your rotor is installed correctly and runs optimally and smoothly

in the test, but suddenly shows fluttering movements when used in the wind or changes direction often, quickly and sharply, then your location – at least at the current hub height – has too much turbulence.

**Should you find that your turbine's operation is very unsteady, that the nacelle is permanently swinging from left to right, that your rotor shakes and makes helicopter noises in operation – then too much turbulence is the reason. In most cases this is a sign that the wind turbine is mounted too low. A nearby tree or house is causing the wind to swirl – turbulence! Please read chapter 8 to understand the reasons and install your turbine in a suitable place.**

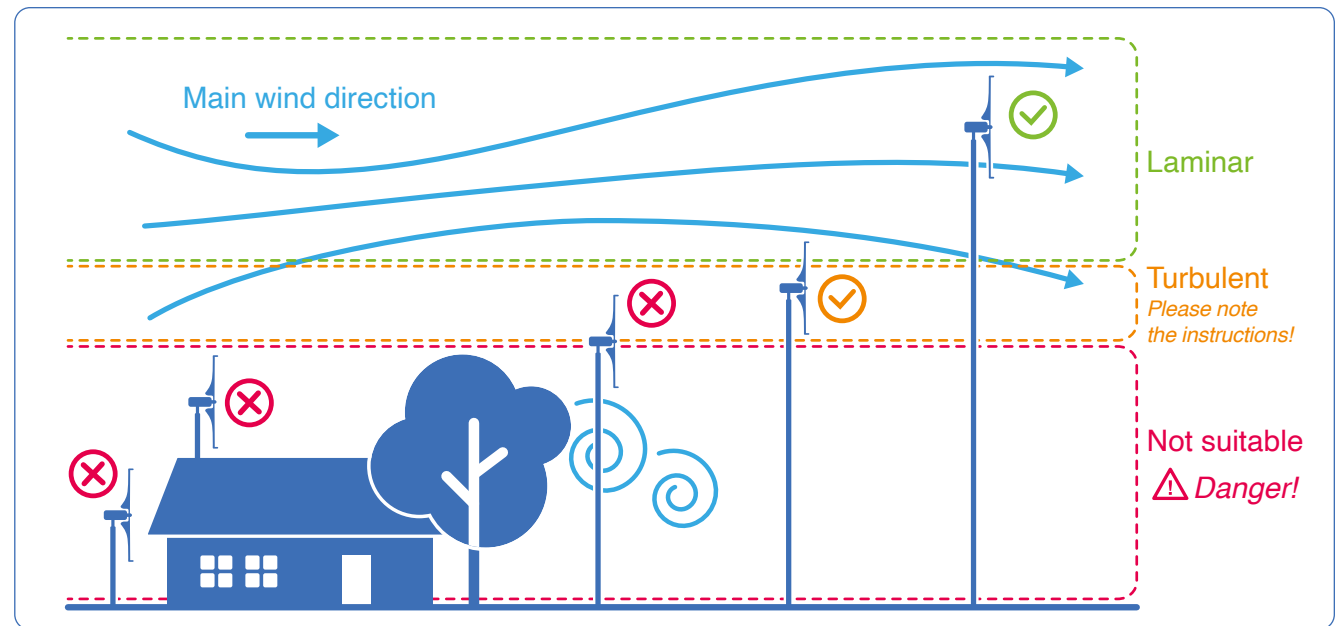

Installation site for laminar flow of wind

## 8. INSTALLATION SITES FOR SKYWIND NG

### 8.2 TURBULENCE

A wind turbine will not work on any site. To avoid losses caused by turbulence and lengthen the life of your turbine the hub must be at least 1.75 m above the highest point of the building. For a flat roof the tower should have a length of at least 1/3 of the buildings diameter. Any turbine must be mounted in at least 10 m hub height above ground and in accordance with provisions made under chapter 8.1.

The **SkyWind NG** can also be used on buildings. Operation on buildings will work best at free-standing buildings, as well as buildings on the edge of towns or slopes (see pictures). If mounted in the town center the wind speed can, depending on the sites conditions, be slowed down by as much as 50%. Also make sure to choose the highest point of the house and check your site using the global wind atlas: [www.globalwindatlas.info](http://www.globalwindatlas.info)

**Use the following rule for placing turbines on top of a standard building:**

- A. Choose the middle of the roof (for single turbine)
- B. Install the turbines approx. 2.5 m to the left and 2.5 m to the right of the buildings center (for two turbines)

Please note the instructions  
on the next page!

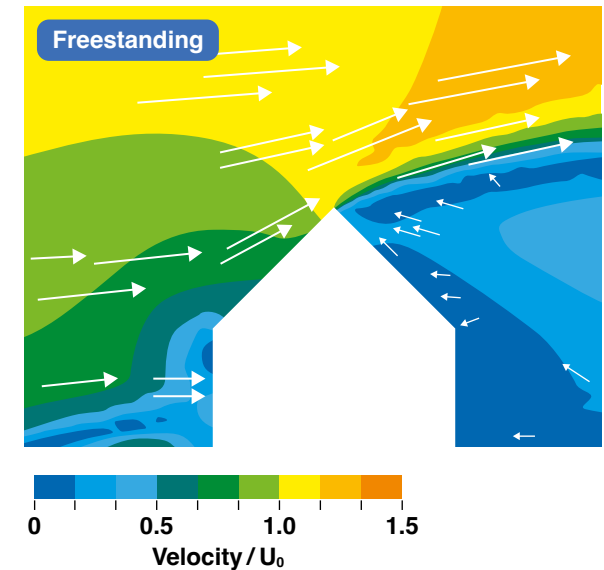
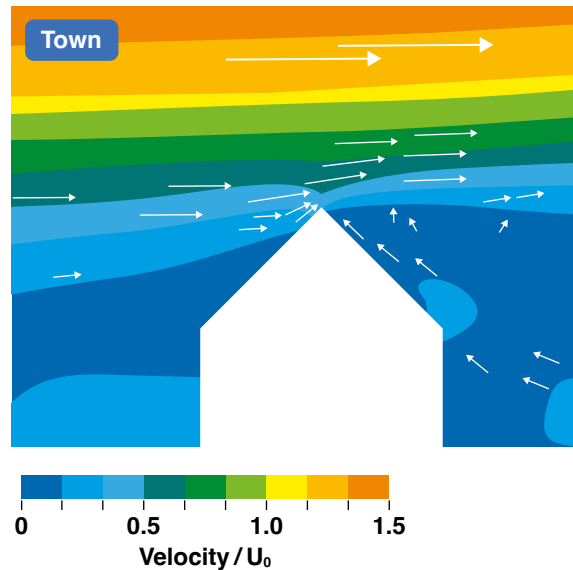

Source: Centre for Renewable Energy Systems Technology (CREST), Loughborough University

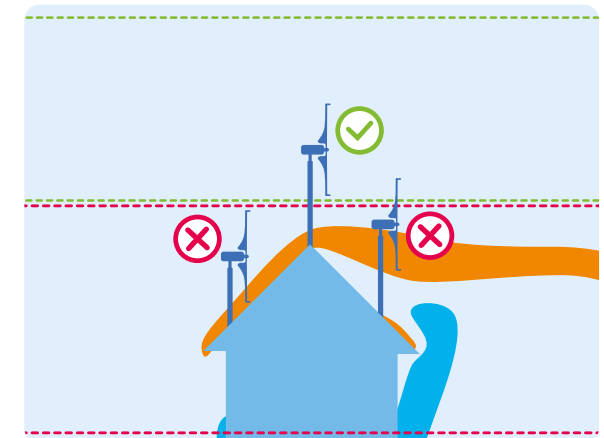
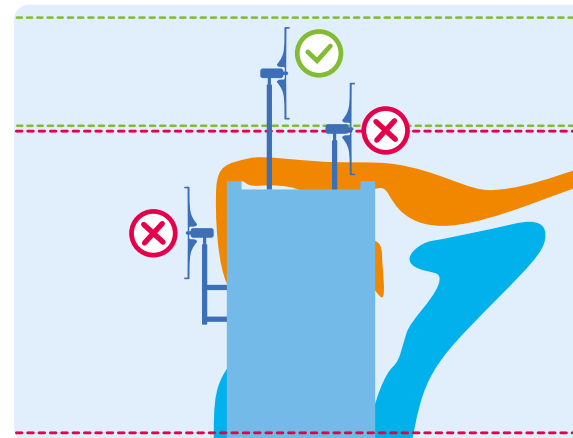



## 8. INSTALLATION SITES FOR SKYWIND NG

The minimum distance between two turbines is 5 m and must always be kept to ensure a proper function of the turbines.

Your turbine must not be installed behind buildings or in the red (turbulent) area above them. You should keep a distance of at least 2.50 m from edges of the roof.

**Turbulence not only results in a significantly lower yield but also causes rotor damage due to extreme load changes on the system. These can extremely shorten the service life and lead to fatigue fractures! SkyWind cannot guarantee that your roof will be suitable. If vibrations occur, the location must be changed.**

 **The turbine must always represent the highest point!**

 **Never install the turbine below the height of a buildings roof or below treetop height.**

 **Stay away from sharp edges, building attics etc. Try to install the turbine as high and free as is possible.**

 **Do not operate the system in locations with strong turbulence. You will only produce a small amount of energy there and the system can be noisy. If there is strong turbulence, the turbine can no longer align itself correctly with the wind and makes a “wobbling”, “shaking” impression – stop operation and change location!**

 **Keep the turbine away from eaves, building edges etc. If the turbine appears to be wobbly and won't lock into the wind direction it is hit by turbulence. Sometimes turbulence can even cause the rotor to shake/vibrate or spin backwards. This can cause damage to your turbine and must be stopped immediately by choosing a more suitable site.**

## 8. INSTALLATION SITES FOR SKYWIND NG

### 8.3 ANNUAL YIELD

Some of the major requirements for successful operation of your wind turbine have already been described on the last pages. Besides a correct installation and a non turbulent site the main ingredient for a well working turbine is obviously the available wind power itself. To predict the success of your project you need to check your sites average annual wind speed.

This can be done by typing your address at [www.globalwindatlas.info](http://www.globalwindatlas.info) and choosing a height of 10 m above ground level.

An example of a yield calculation looks like this:



10 h x Power at 5 m/s (0,04 kW) = 0,400 kWh  
 5 h x Power at 10 m/s (0,275 kW) = 1,375 kWh

Often an (incorrect!) rule of thumb is told on how to calculate energy yield of a site with 5 m/s annual wind speed:



Hours per year (8760) x Power at 5 m/s (0,04 kW)  
 = 350 kWh/Year → **WRONG!**

This calculation does not take into account, that the wind speed will often be more than 5 m/s as this is only the statistic average. But the energy generated per time will increase massively with higher wind speeds.

Twice the wind speed for half as much time will generate almost four times as much energy! For this reason a site with 5 m/s could actually expect about 750 kWh per year instead of the 350 kWh calculated with the (incorrect) rule of thumb.

**To predict how much energy your turbine will generate a computer calculated yield curve for the exact wind turbine type has to be used. This curve must take into account the specific performance of the exact wind turbine type at different wind speeds. For the SkyWind NG you can find this graph on the right.** Only with computer programs and detailed power curves of the wind turbine a reliable prediction of the actual yield becomes possible. Still, this yield may vary by up to +/- 50 % per year (depending on the site) due to seasonal effects and one year being more windy than the other. However, if wind and solar are used together this effect is almost neutralised as a year with less wind will usually provide more sun energy – and the other way around.



Yield estimates are always based on long time annual averages. The actual yield may vary depending on the real situation in that year.



Any site should provide an annual average wind speed of at least 3.5 m/s. Operation is recommended for sites above 4 m/s only.

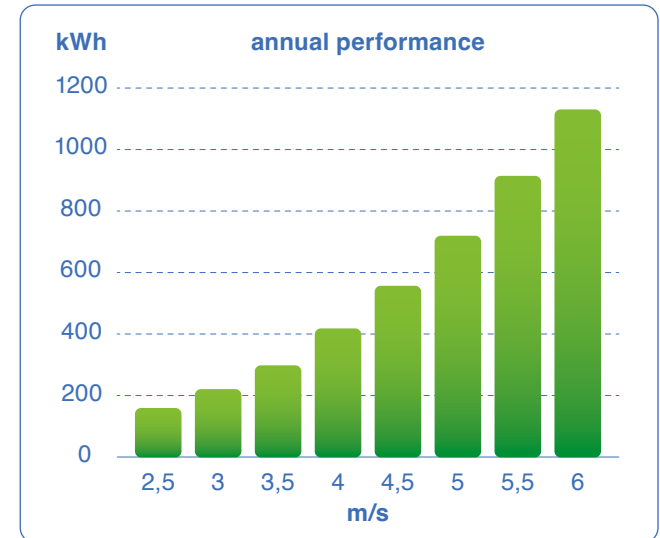

STP 273.15 K | Weibull k = 1.2 – 2.0 | NHN | Tlrep Class C | Setting 800 W AC | Actual performance at the customer depends on the characteristic curve and location. Performance of the battery charging variant differs (max. 30 A current) and depends on battery size, type and state of charge



Never use rule of thumb or “full-load hours” calculations to estimate your turbines yield.



Even the best calculation can only be accurate when the site is free of turbulence and the turbine is installed correctly.

## 9. TOWER

### 9.1 REQUIREMENTS FOR TOWERS

The **SkyWind NG** has been designed to fit on a round tower with a 60 mm diameter. Its unique mount allows installation within literally minutes by sticking the turbine on the tower and tightening two screws – no welding is required at all! However any tower must be aligned **EXACTLY VERTICAL** ( $\pm 2^\circ$ ). A stable tower must not deflect more than  $1^\circ$  under 50 % load. Any tower must provide a hub height of at least 10 m. After installation check that the turbine is free to turn into any direction without turning back on its own by a misaligned tower.

The wind turbines tower must absorb all forces generated by the turbines operation. Technical standards require it to withstand at least three times the maximum force of 250 N generated by the wind turbine. The tower must never resonate within the rpm range of the wind turbine. To guarantee for this no more than 2 m of the tower should be made of 60 mm diameter. Higher towers must always be of a conic shape or be made of several pipes of increasing diameter. The tower must be made of steel of at least 3.0 mm wall thickness.

Contact tower professional if you are unsure which tower to choose. Often lighting poles are used as a cost effective solution with great success. **Consider the turbines resonance frequencies of ca. 10–50 Hz** depending on load and rpm.

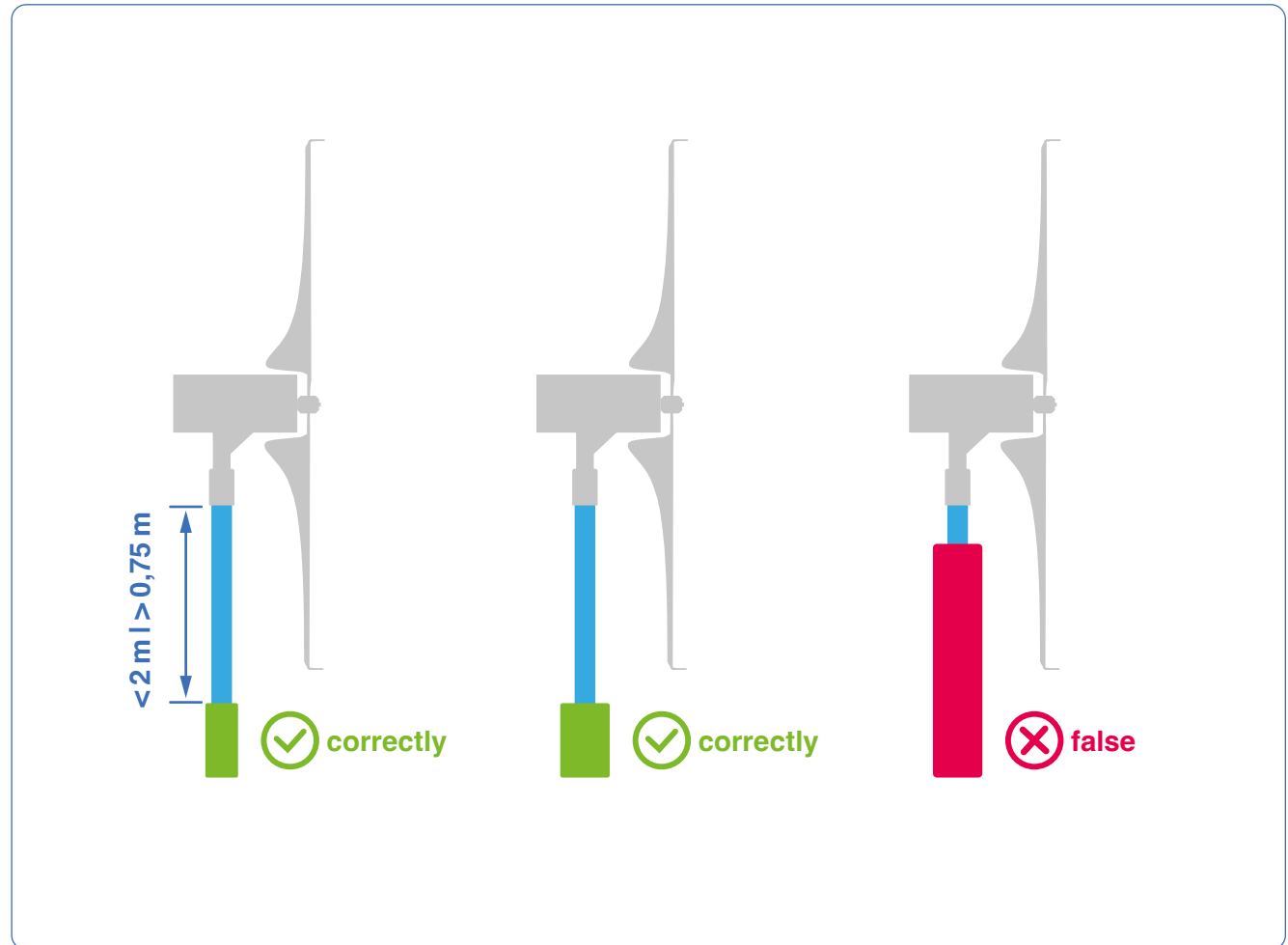

**Immediately stop the wind turbine and modify your tower (e.g. with guy wires) should you find that your tower is resonating!** Any damage caused by excessive vibration and fatigue is not covered by the products warranty.

Please note the instructions  
on the next page!



- ⚠️ A wall thickness of at least 3 mm and a suitable tower diameter are decisive for a low vibration tower that will not shake under sudden loads exerted by gusts. Resonance or swaying will damage the turbine in a very short period of time!
  - ⚠️ Contact your lightning technician if protection is required. The turbine can be connected to your existing lightning protection system if available.
  - ⚠️ Use 60 mm tower diameter for the uppermost 1 m of your tower but never for more than 2 m of tower. Conic or lattice type towers usually work best.
  - ⚠️ Any kind of resonance is prohibited and will damage or destroy your turbine!
  - ⚠️ Always contract a professional for installation. Choose a suitable ground or foundation for your tower construction. Check and respect your local legislation regarding tower installations.
- ⚠️ Always use steel towers (conic tower, steel lattice etc.). Under no circumstances ever is it allowed to use aluminum towers (e.g. flagpoles)! Aluminum will tend to resonate and damage your turbine within very short amount of time.
  - ⚠️ If guy-wires are used make sure the tower top is still perfectly vertical. Use electronic measuring equipment for easy and accurate set-up. Guy wires must be calculated.

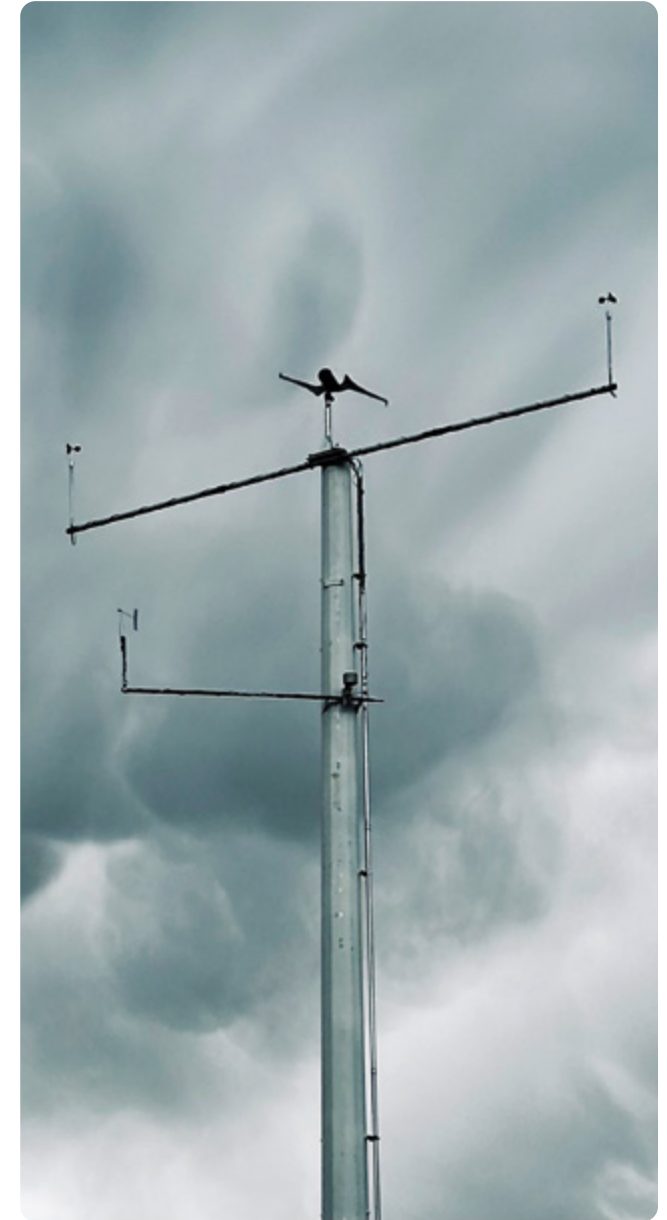

## 9. TOWER

### 9.2 STRUCTURAL STABILITY

Due to the small size of the **SkyWind NG** the tower is not a part of the wind turbine as defined by DIN EN 61400-2. This greatly reduces cost as SkyWind Energy can manufacture, sell and ship the **SkyWind NG** without a mandatory tower system. The owner can use whichever tower is suitable for the turbines requirements and locally available. The patented two bladed rotor is as tiny as 0.08 m<sup>2</sup> each – very much limiting its thrust forces. Still the forces under full power operation in a storm can be substantial:

#### SkyWind NG

- Max. Thrust Force: 250 N
- Rotor Area Covered: 0,16 m<sup>2</sup>
- Operating Frequency: 10–50 Hz

The wind turbines amount of torque to be withstood by the tower foundation is depending on the tower height:

1 m:	250 Nm
2 m:	500 Nm
3 m:	750 Nm
5 m:	1.250 Nm

The thrust generated by the tower and its accessories have to be added to this value. This forces would also greatly increase if the turbine is not shut-off by the storm control at the right time. Always plan the tower with a proper safety margin. **Every structural analysis is required to provide a safety factor of at least 3x times the max. load calculated for the system!**

Keep in mind that the wind turbines operation must be stopped once the maximum operating voltage for the site specific power curve is reached! The wind turbines control systems (Dumpload and Brake) must be programmed according to this manual. Although the automatic storm control is very effective you can extend your turbine operational life by switching it off manually prior to a heavy storm.

**⚠ In regions where Hurricane (SSHWS scale) force wind speeds (119+ kph) are possible the rotor has to be dismantled before such an extreme wind event! Alternatively the turbine can be mounted to a tiltable mast which is tilted prior to the hurricane.**



## 9. TOWER

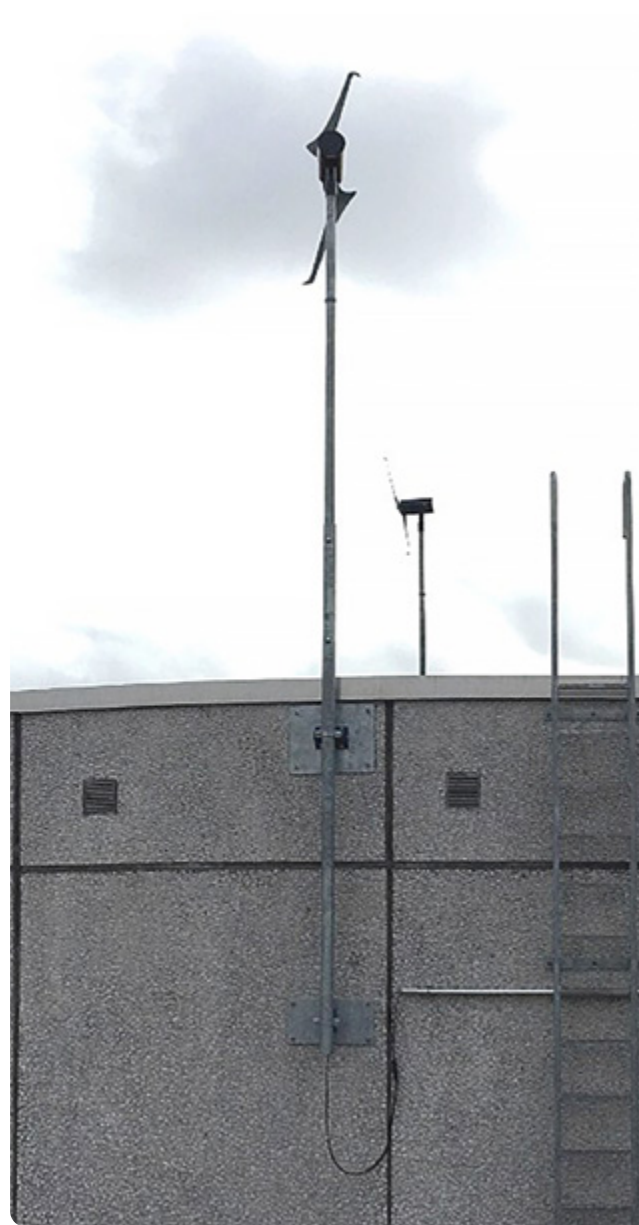

## 10. WIRING/ELECTRICAL CONNECTION

### 10.1 WIRING

Please follow these guidelines when wiring the **SkyWind NG**:

#### Always use:

- **Red cable** to wire the + DC-pole and
- **Black cable** to the - DC-pole of your wind turbine.

The main ON/OFF Switch has to be installed as shown in the wiring diagrams (see 11.). It must switch off the entire system! The generator must be DC short circuited once the main switch is set to OFF. Only use Solarflex®-X solar cable and crimp connections for your DC-wiring (see 10.7).

#### Always use:

- One, and only one, inverter or charge controller per turbine.
- The automatic storm control system delivered with your **SkyWind NG**.
- **No additional generators** (like solar etc.) on the same DC-circuit.

Always and only use charge controllers or inverters that are meant and tested for use with the **SkyWind NG** micro wind turbine.

Under no circumstances is it allowed to install the rotor blade if no charge controller /grid inverter and storm control are installed and active! (see 10.3 etc.)

**Do not use DC-heating elements directly connected to the SkyWind NG generator!** Always operate **SkyWind NG** with charge controller/grid inverter and a storm control system.

 **Attention: Protect all outside cables, especially the DC-cabling. Only use proper Solarflex®-X cable for DC-installation. Satisfy all applicable standards for electrical connections and cables.**

 **Attention: Do not hang more than 20 kg of cable weight underneath the wind turbine.**

 **Always use copper wire to prevent corrosion problems.**

 **Contract professionals for your installation! Electricity can cause deadly harm!**

 **Avoid contact between different materials (e.g. copper and aluminum). You might create a galvanic cell, corroding the contacts.**

 **All cables and connections should be checked regularly for signs of wear or corrosion and correct function. An electrical failure or braking cable can cause destruction of your wind turbine!**

 **NEVER, NOT FOR A SINGLE SECOND is it allowed to connect the generator directly to an inappropriate power source (e.g. 110/230 V grid, batteries). This will immediately cause destruction of the wind turbine and might be deadly!**

## 10. WIRING/ELECTRICAL CONNECTION

### 10.2 GRID INVERTER

Your **SkyWind NG** micro wind turbine includes a high-end MPPT wind power grid inverter computer. The inverter will control the turbines power output and rotor rpm several thousand times per second to generate the highest possible energy yield. However, to perform its task as efficient and safe as possible, the computer has to be set to fit your local conditions.

#### BRAKE/DUMPLoad

Your inverter connects with a dumpload to limit the rotational speed of your generator and not having to use the storm control for every gust. The dumpload is included in your delivery and will get hot while braking the rotor in gusts. Install the inverter and dumpload in a safe place without fire hazard and connect the heating element to the “DUMPLoad” contacts located on the top cover of your inverter.

**Do not install the dumpload directly on a conductive surface – use insulation and plastic screws if installation on metal surfaces cant be avoided.**

#### MULTIFUNCTION LCD-DISPLAY

Your inverter computer provides a coloured main LCD-display. Via this display and the buttons next to it you can check for the turbines performance, grid and turbine voltages, current power output and much more. To function correctly your inverter has to be programmed to your specific conditions.

The main menu “Power view” will display all key data of your system. If the display is showing a “Starting Voltage Too Low” message the wind speed is not sufficient for power generation (below 22 V DC). The inverter will wait for the turbine to fully start-up before starting actual power generation.

#### ATTENTION:

*The “Brake/Dumpload” function is an additional braking system and does NOT replace the automatic storm control. The turbine will always need the automatic storm control system!*



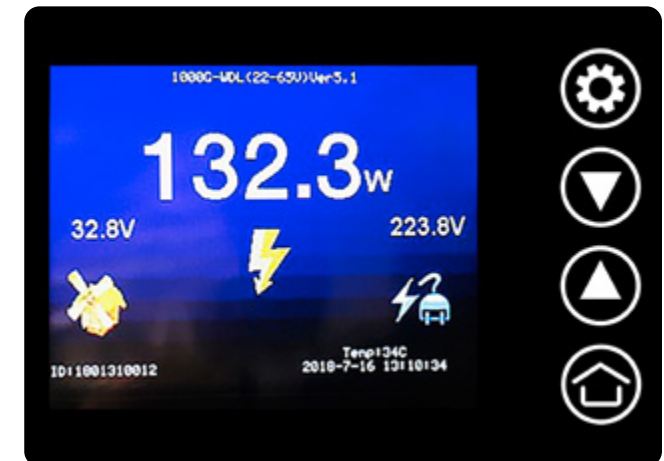

Grid inverter with LCD display and control buttons



Main “Power View” display during normal operation

## 10. WIRING/ELECTRICAL CONNECTION

### 10.3 SETTING UP THE INVERTER



To start the process push the  *House button* on the right side of the display. Use the “up” and “down” arrow buttons to navigate to the  *Gear Wheel symbol* on the display. Select it by pushing the  *Gear Wheel button* on the right side of the display.



Navigate to the “*Current Curve Adjust*” tick-box using the arrow buttons and activate it by pushing the  *Gear Wheel button* on the right side of the display. Now enter the **power curve “Basis”** printed below. You may later select the 600 or 800 Watt peak power setting.



**Power Curve “Basis”** (Must be set on all SkyWind turbines):

23 V	26 V	30 V	34 V	38 V	42 V	46 V	50 V	52 V
015	080	175	210	230	250	255	255	255

A selection between power curve A or B, as in older versions of the **SkyWind NG**, is not required with this power curve.

Now navigate to the first data field (23 V) using the *arrow buttons* and activate it with the  *Gear Wheel button*. Use the *arrow buttons* to select the right value from the power curve. Then confirm the value by again pushing the  *Gear Wheel button*. Proceed by entering the entire power curve.

After finishing with the 52 V value, navigate to the “*Dumpload*” tick-box and activate it by pushing the  *Gear Wheel button*. Next select the voltage value and set it to 50 V. Once again confirm your selection by pushing the  *Gear Wheel button*.

Finally push the  *Home button* on the right of the display. A menu will pop-up asking you whether you would like to save your entries. Navigate to the “*Yes*” option and confirm it by pushing the  *Gear Wheel button*. In menu the selected option (*YES/NO*) is highlighted in red colour.

**For turbulent sites or the most quiet Operation choose the 600 Watt peak Power setting as this will generate the least amount of loads.**

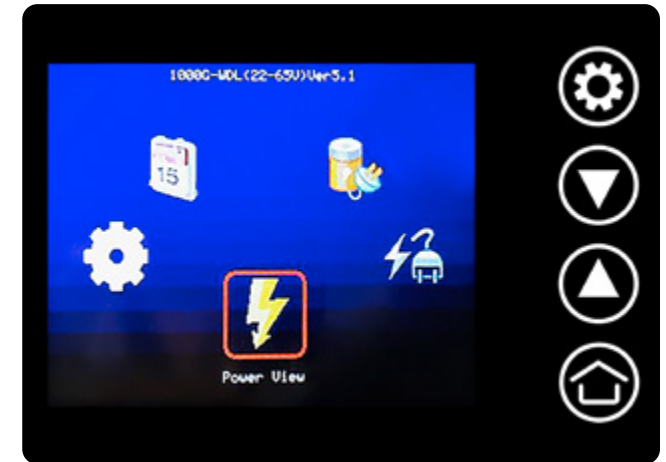

The inverter main menu

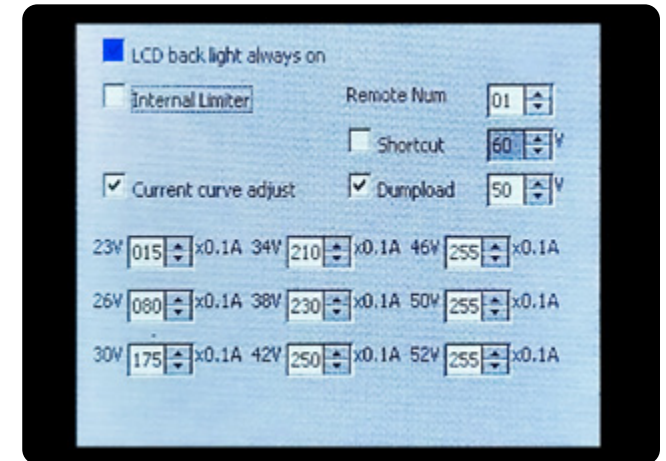

The power curve adjustment menu

## 10. WIRING/ELECTRICAL CONNECTION

### 10.4 CORRECTION FOR HEIGHT ABOVE MEAN SEA LEVEL/AIR DENSITY

A wind turbine will only work correctly and safely if it is set-up correctly. Apart from what many people think the set-up does not end with a correct wiring, but includes a correct power curve (and storm control) program as a vital component! If the inverter tries to get more power than the turbine can deliver the turbine will actually stop generating power – much like “stalling” a car engine. With increasing height the power output will be less for the same wind speed.

The higher a site is above mean sea level the thinner the atmosphere will be. A thinner atmosphere means less mass flowing through the rotor at the same air speed and thus less power. The turbine must correct for this by working with different rpm. If your site is not within 1500 m above or below sea level your turbines computer has to be adjusted. In this case enter the power curve that fits your turbines height above sea

#### Power Curve C:

Height above MSL	23 V	26 V	30 V	34 V	38 V	42 V	46 V	50 V	52 V
0–1500 m	Power Curve “Basis” (p. 36)								
1501–1999 m	014	075	165	200	210	230	255	255	255
2000–2999 m	013	070	155	190	200	220	230	255	255
3000–3999 m	012	065	145	180	190	210	210	230	255
4000–4999 m	011	060	140	170	180	200	210	220	230

level using the same procedure shown on the last page. **The settings for Dumpload and automatic storm control are the same as for the “Basis” power curve.**

**Power Curve C: Choose the correct height above MSL for your turbines site (see table below).**

Use the same procedure shown on the last page to set the power curve in your computer.

**Correctly choosing and setting the power curve is very important for both safety of operation and power production!** A wrong selection of the power curve might not only damage your turbine, you will also find that it is generating almost no energy at all. Imagine it for your turbine to be like trying to drive your car with the wrong gear selected: Start driving in highest gear – it just wont work! Driving on the highway in first gear? Not very efficient! Take your time to fully understand your site and your wind turbine and set-up everything correctly right from the beginning.

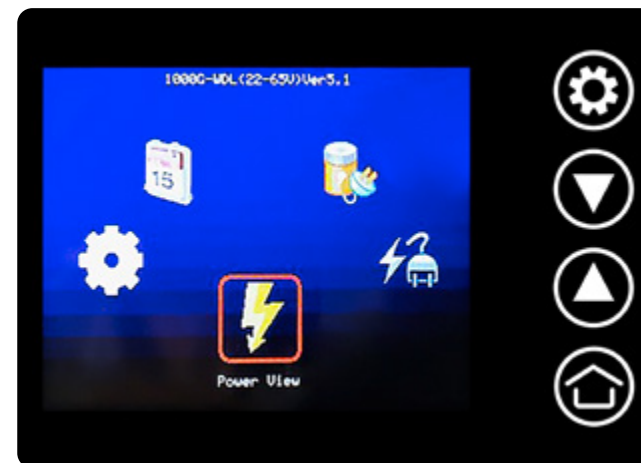

The inverter main menu



The power curve adjustment menu (sample)

## 10. WIRING/ELECTRICAL CONNECTION

### 10.5 TEMPLATE AND DOCUMENTATION OBLIGATION

Your inverters power curve setting menu **must** look **exactly** like this if you have set up your **SkyWind NG** turbine correctly for a site in standard conditions around mean sea level! Document your settings with both a picture with visible date in the picture and a written documentation. Store the picture and your documentation well – you will only be able to claim your warranty if you can prove a correct installation and set-up! The warranty is void if a correctly set-up inverter and site suitable power curve can not be proven.

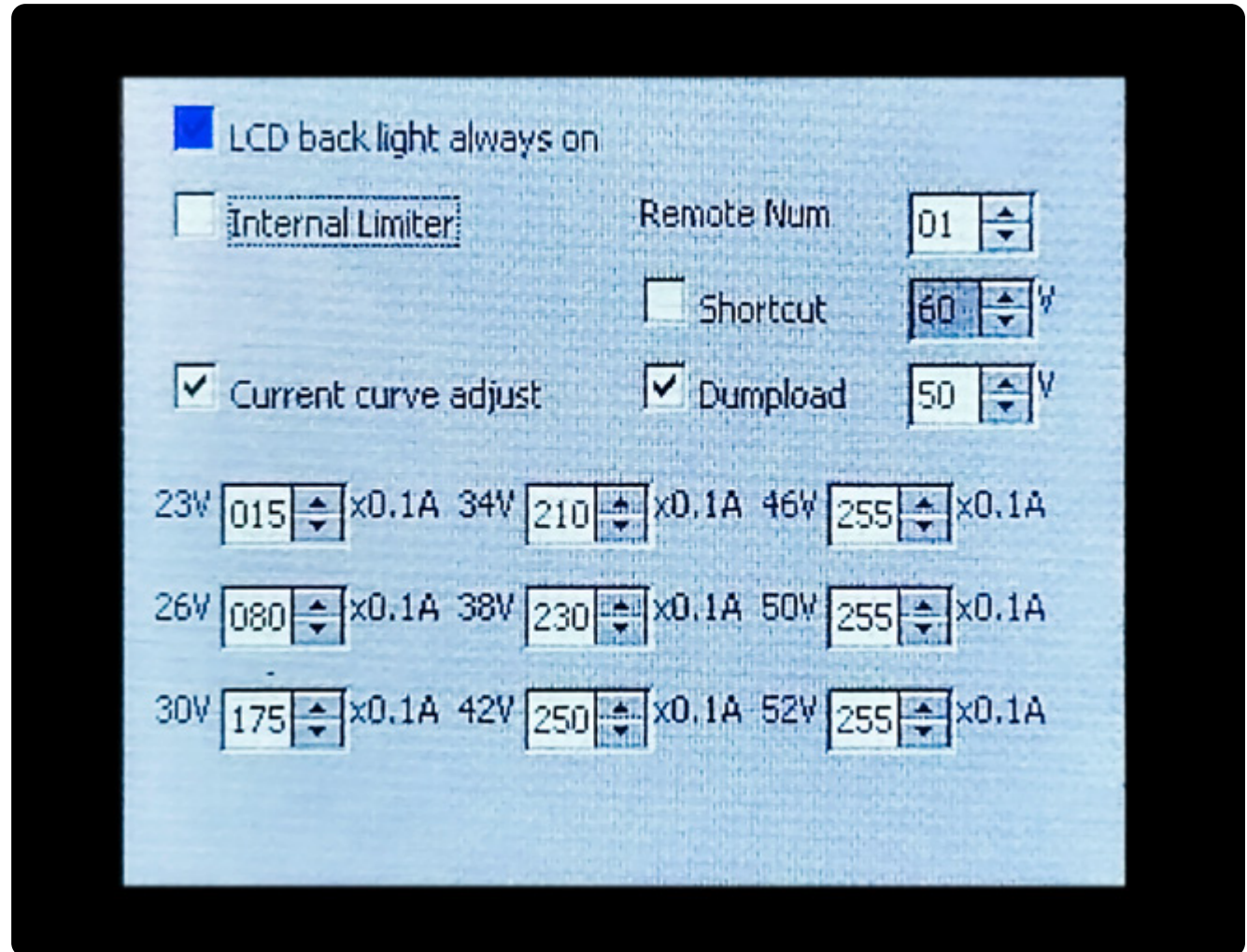

### 10.6 AC-WIRING

Please be aware that any work on the wind turbine system must be performed by trained professionals only (p. 6).

SkyWind Energy is only delivering components for a wind energy converter. SkyWind can not make any statement or will not warrant whether these components are suitable for a specific project or not. SkyWind does not know whether a combination with a certain battery system, electric appliance or home grid will work or not. SkyWind Energy does not warrant compliance or compatibility with certain electrical standards, whether national or by the local grid provider. It is not a defect of the wind turbine if the customer can not use it with a specific project due to regulation or special electrical requirements at the customer's chosen site.

As most current generation wind inverters SkyWind will not follow the frequent changes in European grid regulation anymore. Our inverter is compliant with the VDE-AR-N 4105 and the VDE 0126-1-1 – some of the highest standards in the world. Should a specific country mandate require separate national standards, a separate protection device as requested by the specific grid provider may be required. This is the same for most Photovoltaic-generators or other equipment. Your trained professional will perform the AC-connection in compliance with the national standards.

**The specialist company must mount all AC-components, in particular the relays, in safe control cabinets protected against unauthorized access. He must use insulated cable shoes for the JQX-38F relay. Unauthorized access to the controller must be excluded. Only the main switch must be available to the end user. Settings on the system may only be made by qualified personnel.**

#### **ATTENTION FOR 110 V/12 V/24 V:**

*For use with 110 V AC-grids or use with 12/24 V DC-battery systems a 230 V AC-power adapter (not included) is required to power the storm control system. The storm control system will always require 230 V AC in order to operate. A very small adapter is sufficient as the system will require less than 10 W to operate. The SkyWind NG grid inverter will detect the 110 V AC-system and synchronize with it. No further actions or equipment are required for it.*

**⚠ Set-Up the grid inverter, the storm control and other equipment according to this manual. Document every setting!**

**⚠ Always install the automatic storm protection that will stop the wind generator immediately when 40 V DC are reached! Inform the customer that the manual ON/OFF may not be used more than once per hour. For peak powers of 600 or 800 Watt a lower voltage must be set for the storm control (32,5 or 35 V).**

**i** Make yourself familiar with the regulation in your country and for your site. A trained professional will always install the system in accordance to regulation and legislation.

**i** Use a proper fuse, wire diameter and protection for the wind turbines AC-supply. Install additional equipment if required by national standards.

**⚠ Always contract trained professionals for any kind of work on the system! Document the set-up! Never change anything yourself.**

**⚠ Take care of the level of protection of different parts. Electronic components may not be installed outside and only in non-condensating humidity.**

**i** The inverter does not require an external residual current circuit breaker for operation. If local regulations require an RCD: The inverter is compatible with type A residual current circuit breakers that actuate at a current of no less than 100 mA.

### 10.7 WIRE CROSS-SECTION

You must use a proper wire cross-section in all electrical installations. Although this is always important, this topic must be considered in very much detail for the wind turbines DC-connection. A too small wire cross-section will have a very negative effect on the turbines performance.

**Any wire length in excess of 30 m between generator and inverter is prohibited. Violation will cause damage to your turbine and may lead to total loss of power generation of the turbine. Determine the DC-wire length your installation will require from the turbines generator, through the mast, all the way to the inverter. This should not be more than 30 m. Always use 6 mm<sup>2</sup> cross-section Solarflex®-X cable (by HELUKABEL) or equivalent inside the turbine and tower.**

Plan to use red coloured wire for positive and black or grey colour for negative. If less than 20 m of cable are required you may use 6 mm<sup>2</sup> cable (AWG 9 or 10) all the way. If more than 20 m are required you should change to 8 mm<sup>2</sup> (AWG 8) immediately after leaving the tower. If you follow these guidelines your cable losses will usually be 5 % or less.

If regulation or legislation requires different (larger) cross-sections the trained professional will always follow the regulation.

Lay all DC-cabling according to professional standards. Leave about 20–30 cm (ca. 1 ft) of loose cable after the point where the cables leave the tower. This way the cable can move inside the tower without strain on the cable exit.

**Up to 20 m = 6 mm<sup>2</sup>**

**Up to 30 m\* = 10 mm<sup>2</sup>**

*\* Always use 6 mm<sup>2</sup> inside turbine and tower!*

 **Be aware that using the wrong type of cable (e.g. speaker cable), too little cross-section (e.g. 1.5 or 2.5 mm<sup>2</sup>) may stop your turbine from working at all or even lead to total destruction of the system.**

 **Keeping the DC-wiring as short as possible and using a sufficient cross-section for the wiring is the easiest way to gain more performance in your wind turbine system.**



### 10.8 OPERATING STATES OF SKYWIND NG

#### A) OPEN CIRCUIT (⚠️ DANGER!)

If the turbine would not be connected to a charge controller/grid inverter and the storm control system it would rotate without load. **This state would be extremely dangerous as the rpm will increase ever further until the rotor blades disintegrate!** Do not mount rotor blades to the nacelle if the electric installation is not finished and working properly. In case of an emergency use the OFF switch of the the turbine. Never remove cables or contacts or even touch the cables once installation is finished.

#### B) NORMAL OPERATION

If the generator is connected to the grid inverter or charge controller it will generate power. The rpm is regulated by the controller. The turbine should be rather quiet since all energy generated is immediatly converted into electricity and discharged through the cables. The actual performance and noise is depending on the site, selected power curve and/or battery state.

#### C) BRAKE/SHUT-OFF

If the turbines main switch is set to OFF or if the storm control detects too high winds the turbine will be shut-off. The rotor blades will almost stop rotating within seconds and the turbine will stop generating power immediatly. The generator is heating up during this process. The turbine can continue working after one hour, either because the storm control reactivates the turbine automatically or because the main switch is set to ON. The main switch may never be used more than once per hour. After reactivation the turbine will resume operation in normal operation.

**Every SkyWind NG must include a shut-off switch and an automatic storm control.**

⚠️ **A turbine operating without load might not only disintegrate, the increased loads on tower and structure might also damage or destroy your tower and foundation.**

⚠️ **A SkyWind NG turbine must work smoothly in normal operation mode. Should you find that the turbine vibrating or not generating power stop operation and check all aspects of the system.**

⚠️ **Use only the original SkyWind NG inverter or charge controller and automatic storm control. Never switch parts or use equipment not sold by SkyWind Energy specifically for the SkyWind NG.**

⚠️ **Install the AC-main switch as shown in the wiring diagrams. Any fuse or RCCB must be installed outside of the system (before the main switch)**

⚠️ **Never and not for a single second is it allowed to operate the turbine without load in open circuit mode!**

⚠️ **Never use any kind of WAGO® or other clamps within the DC-system. Do also not use relay sockets for the JQX-38F.**

## 11. WIRING DIAGRAM/STORM CONTROL (CAUTION: ACCURACY)

### 11.1 GRID OR AC-CONNECTED INSTALLATION

On the right you see the wiring diagram for an AC-connected **SkyWind NG** micro wind turbine.

Follow the instructions exactly and do not deviate from this diagram. Any changes might affect the safety of the system and can cause destruction of the wind turbine within seconds.

**Installing the storm control requires two steps:**

- a) Installing and wiring the components
- b) Setting-Up the storm control unit correctly

Both steps require accurate work to guarantee for a successful, safe and long lasting operation of the wind turbine.

If installed on a 110 V AC-grid the inverter must be connected to your standard 110 V AC-grid. The storm control system including relays etc. must be supplied with 230 V AC by a transformer (10 Watts or more). In case of any questions contact the SkyWind Energy technicians.

 Document the wiring and the settings with both written notice and dated pictures of your settings. No warranty is granted if the correct installation cannot be proven!

 **Install all electric components in a protective enclosure. Follow the relevant VDE regulation and legislation. Never use other parts than those delivered by SkyWind Energy!**

 **Install an AC-switch that can enable or disable the AC-supply of the system. This switch can be used to shut-off the entire wind turbine, but may only be used every 60 minutes.**

 **Both the timing relay and the storm control unit must be set up as described on the next pages. This set-up and the settings must be documented! A storm control that has not been set-up properly provides NO protection at all!**

 **Under no circumstances may any other parts (fuse, RCCB etc.) be installed into the wind turbine (wiring diagram depicts the entire system ,wind turbine')!**

 **Remember to connect the contacts no. 1 and 7 of the high energy relay (JQX38f).**

Please note the wiring diagram on the next page!



# 11. WIRING DIAGRAM/STORM CONTROL (CAUTION: ACCURACY)

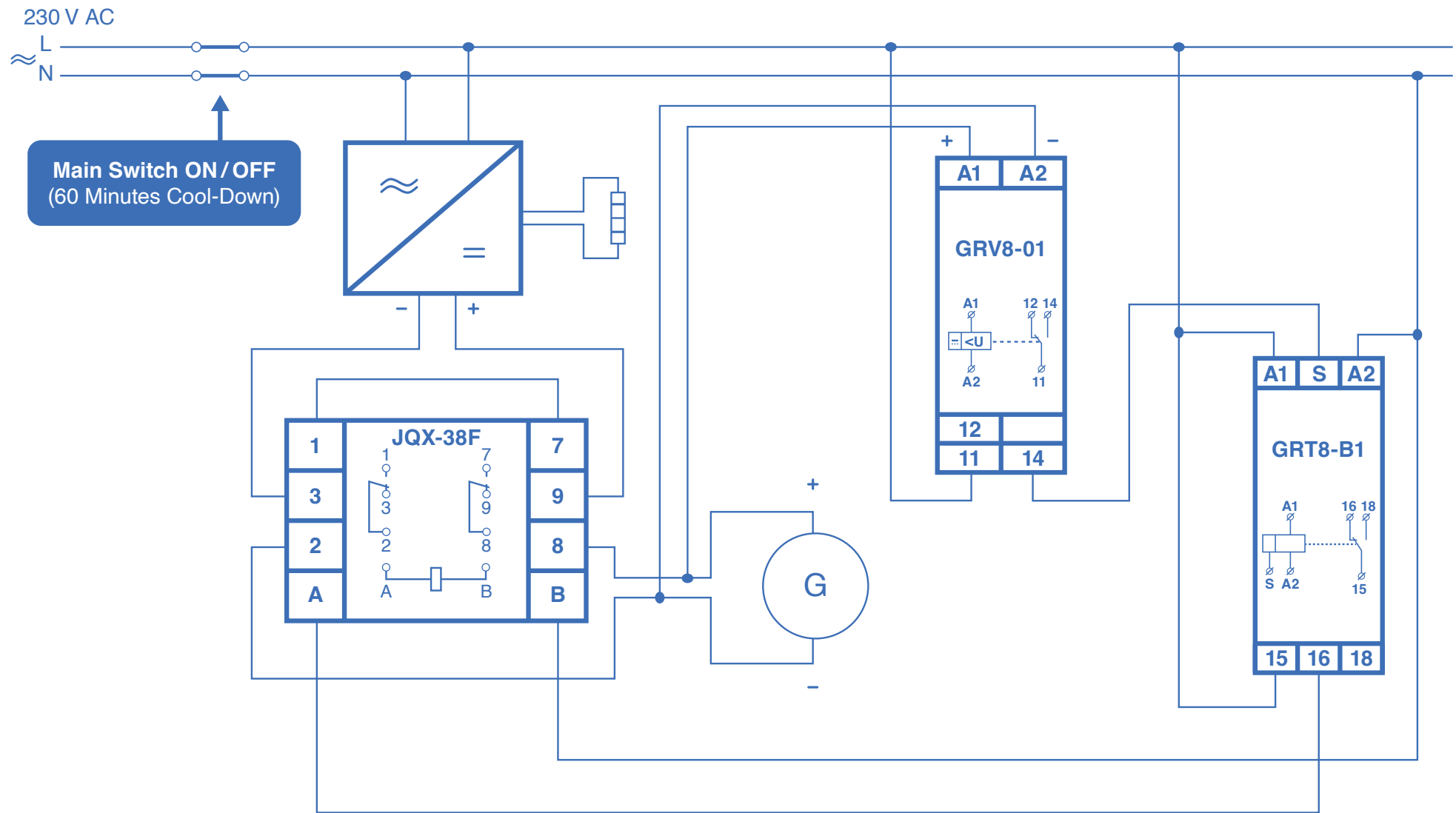

**Main Switch ON/OFF**  
(60 Minutes Cool-Down)

## 11. WIRING DIAGRAM/STORM CONTROL (CAUTION: ACCURACY)

### 11.2 BATTERY CHARGER OR DC-INSTALLATION

On the right you see the wiring diagram for a 12 or 24 V DC-connected **SkyWind NG** micro wind turbine.

Follow the instructions exactly and do not deviate from this diagram. Any changes might affect the safety of the system and can cause destruction of the wind turbine within seconds.

**Installing the storm control requires two steps:**

- a) Installing and wiring the components
- b) Setting-Up the storm control unit correctly

Both steps require accurate work to guarantee for a successful, safe and long lasting operation of the wind turbine. Remember to document your set-up and settings in detail.

 Document the wiring and the settings with both written notice and dated pictures of your settings. No warranty is granted if the correct installation cannot be proven!

 **Install all electric components in a protective enclosure. Follow the relevant VDE regulation and legislation. Never use other parts than those delivered by SkyWind Energy!**

 **Install an AC-switch that can enable or disable the AC-supply of the system. This switch can be used to shut-off the entire wind turbine, but may only be used every 60 minutes.**

 **Both the timing relay and the storm control unit must be set up as described on the next pages. This set-up and the settings must be documented! A storm control that has not been set-up properly provides NO protection at all!**

 **Under no circumstances may any other parts (fuse, RCCB etc.) be installed into the wind turbine (wiring diagram depicts the entire system ,wind turbine')!**

 **Remember to connect the contacts no. 1 and 7 of the high energy relay (JQX38f).**

Please note the wiring diagram on the next page!



# 11. WIRING DIAGRAM/STORM CONTROL (CAUTION: ACCURACY)

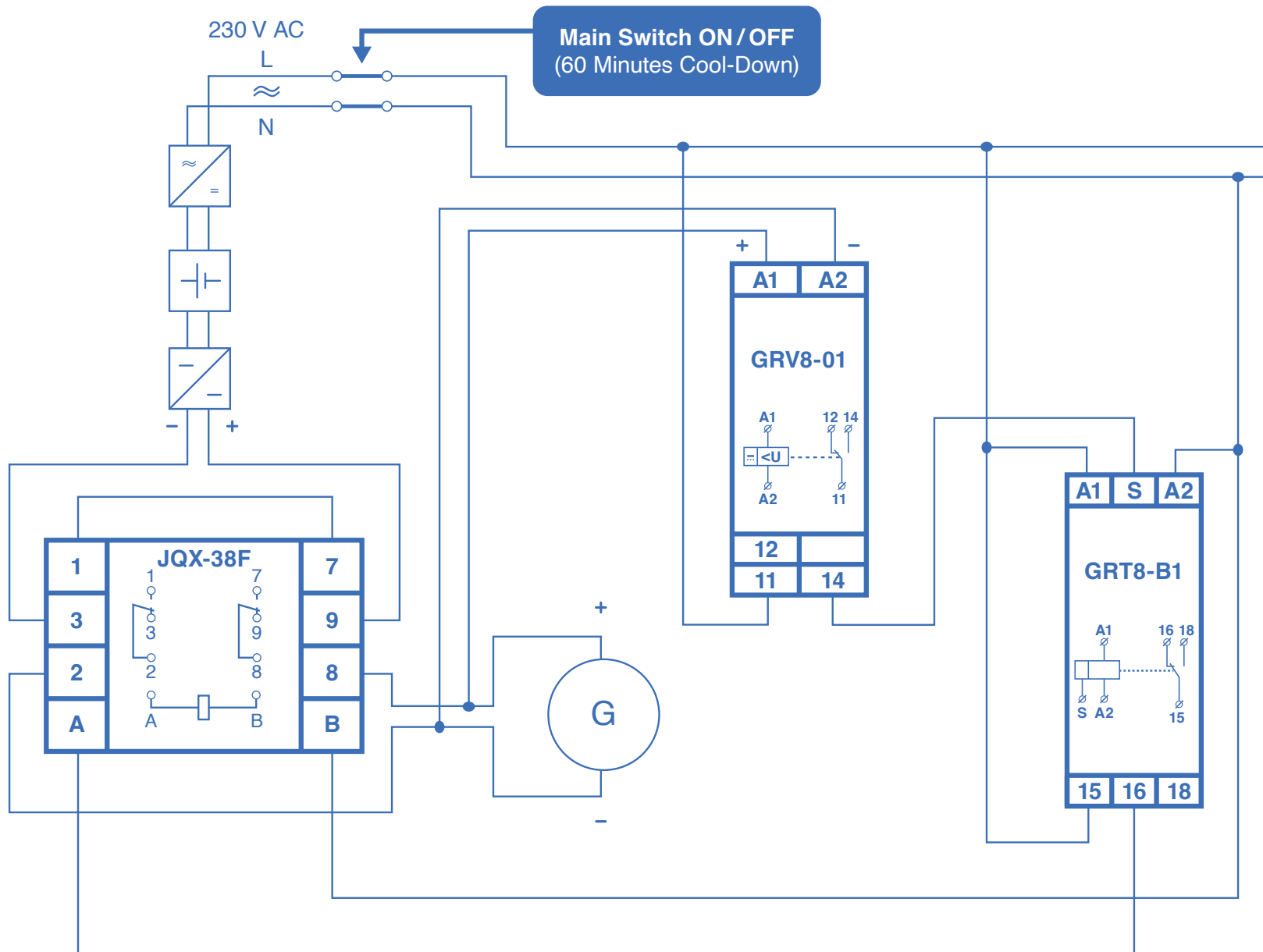

# 11. WIRING DIAGRAM/STORM CONTROL (CAUTION: ACCURACY)

## 11.3 SETTING UP THE STORM CONTROL

Every SkyWind NG micro wind turbine must be shut off automatically once a voltage of 40 V DC is reached. Once the automatic stop has been activated the turbine must stay shut-off for 60 minutes to cool down.

**For a peak power of 600 Watts the turbine must be stopped at 32,5 V. For 800 Watts the storm control must be set to 35 V.**

The turbine must also stop immediately once the AC-grid fails (power outage). Only with this automatic storm control system active and working may the rotor blade be mounted to the wind turbine!

Please note the wiring diagram on the next page!



The **GRV8-01** is the main control unit of the automatic storm control system. It constantly measures the DC-operating voltage of the turbine and immediately activates the GRT8-B1 time delay relay once the critical max. voltage of 40V DC is reached. The control unit must be set-up as described below:

- Select: U < Unlocked
- Select: 0%
- Select: 0 s

Select:  
 Max. 600 W = 32,5 V  
 Max. 800 W = 35 V  
 Max. 1000 W = 40 V

The **GRT8-B1** time delay relay controls the JQX-38F high-energy relay which stops the turbine. It must also ensure that, once the automatic storm control has been activated, the high energy relay does not restart the turbine before the cool-down time of 60 minutes has elapsed.

- Select: 1h (One hour)
- Select: 100%

# 11. WIRING DIAGRAM/STORM CONTROL (CAUTION: ACCURACY)

Wiring diagram for SkyWind NG (AC) with noise control

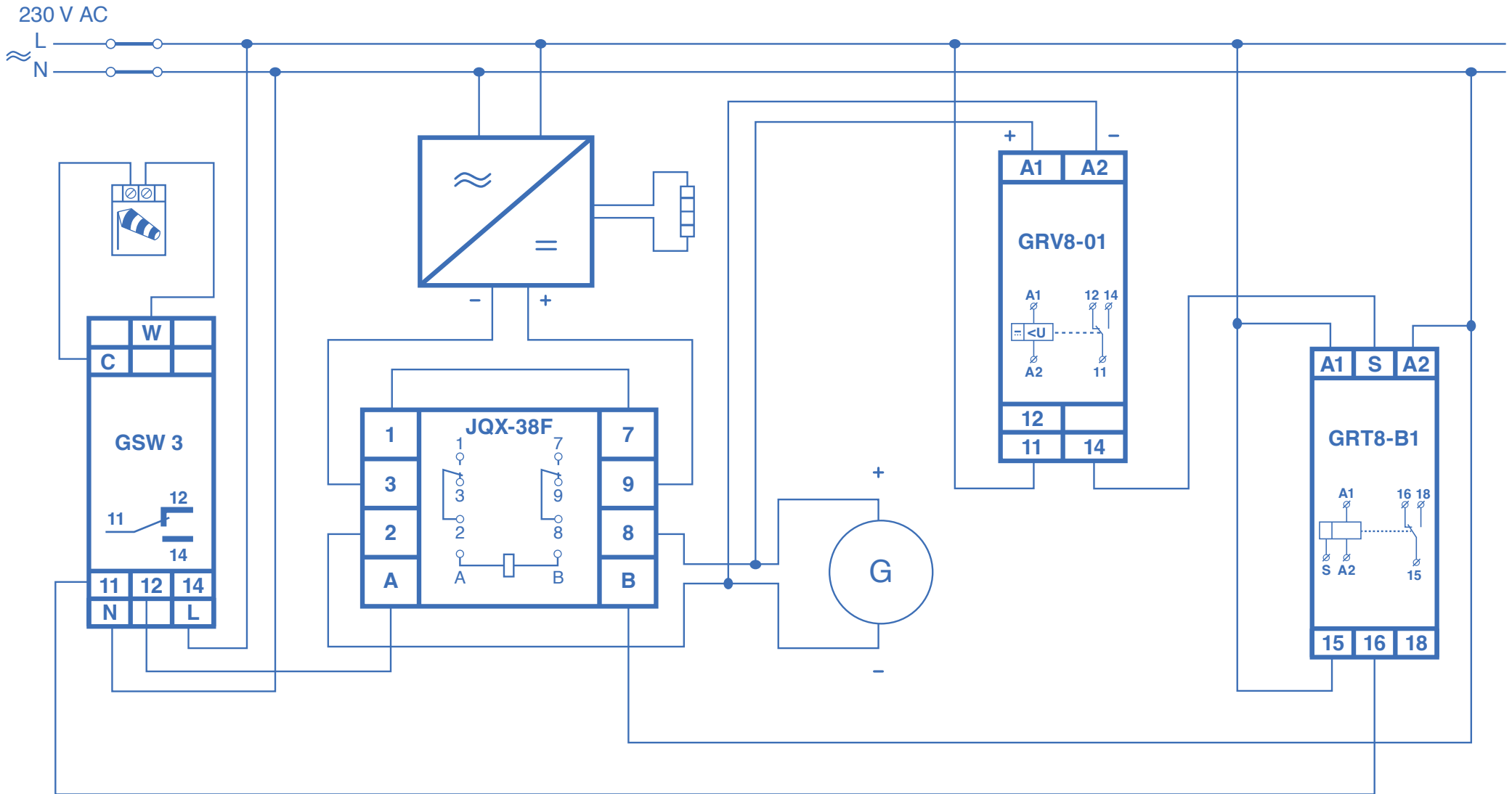

Please note the instructions on the next page!



## 12. OPTIONAL NOISE CONTROL (CAUTION: ACCURACY)

For an even more quiet operation choose 50 kph activation wind speed. In case of a sudden gust which might normally create more noise than normal operation the wind turbine will be shut down for five minutes (cool-down time!) before restarting.

- i** The length of the signal cable between wind sensor and control unit must not exceed 25 m.
- i** The wind speed may be selected anywhere between 30 to 50 kph. Anything below 30 kph will stop the turbine immediately after generation started, anything above 50 kph will have little effect on the actual noise levels.
- i** Document the installation and settings by pictures showing the date in the picture. Only a correct set-up will stop the turbine!

**⚠** The wind sensor of the noise control must be located 0,25 m below the rotor. The noise control is useless if the wind sensor is covered by the rotor or installed away from the turbine!

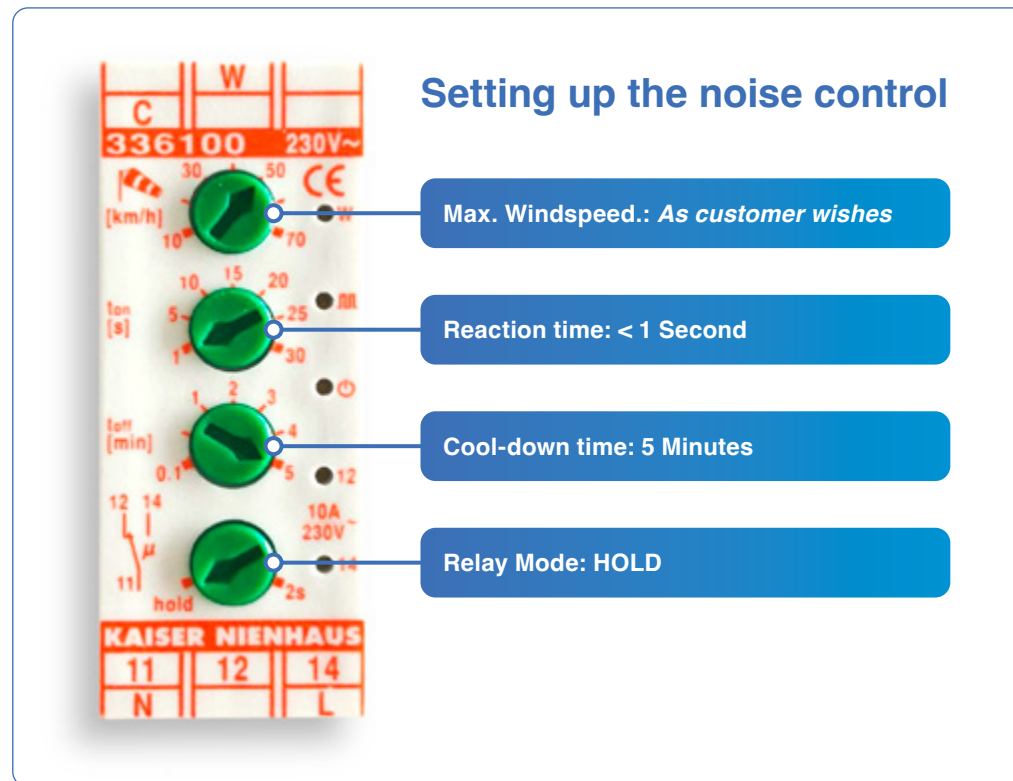



## 13. INITIAL START-UP

### 13.1 ELECTRICAL INSPECTION AND MECHANICAL TEST

The installation of a **SkyWind NG** micro wind turbine is not complete until the following tests and inspections have been successfully performed on the completed turbine. The person installing the machine or mounting it to the building is responsible for compliance with this manual, as well as the state of the art. You will need:

1. A laboratory power supply with control range: 0–25 volts, 0–5 amps
2. Cable with banana plugs for laboratory power supply: At least 2.5 mm<sup>2</sup> conductor thickness, 1–2 m length

After completing your entire installation, i.e. also **after the Loctite® glue has cured**, start with the initial start-up procedure.

1. Connect the laboratory power supply to the DC-INPUT of the inverter via the banana plugs and switch it on at setting 0 V, 0 A. The turbine and storm control remain connected at the same time – leave the whole setup of the turbine unchanged.
2. Now set the main switch of your wind turbine to ON for the first time. Wait until the red LED on the GRT8-B1 stops flashing after 60 min. Afterwards you must hear the relay switch (click sound).

3. Now set the power supply to allow up to 5 A and initially regulate approx. 5 V. Check that the rotor is rotating. Check that the rotor blade rotates in the correct direction (*clockwise – viewing direction: rotor in front of mast*). Note the Amps in your documentation. Then increase voltage to 15 V and note the current again.

4. Now slowly increase voltage to 25 V and check that the rotor blade is rotating at high speed and that the inverter is feeding power to the grid. Check that the rotor and nacelle do not vibrate or shake. Document feed-in power and current output of the lab power supply. Now also check that the green LEDs of your storm control system (GRT8-B1 and GRV8-01) are both lit.

5. Now set a value of 20 V on the voltage regulator of the GRV8-01 (second dial from the top). Thereupon the relays must switch and the green lamp on the GRV8-01 must go out immediately. The red LED on the GRT8-B1 starts to flash and blink. The rotor of the wind turbine must stop immediately (within 2 seconds!)! Now switch off the power supply unit. The rotor of the wind turbine remains braked. Turn the rotor by hand (if you can), it must stop again immediately.

6. Now reset the strom control to the correct values (see chapter 11.3). Wait until the red LED of the GRT8-B1 stops flashing. Now switch on the power supply with 5 V and regulate it slowly up to 25 V again. Then switch the wind turbine off by using the main switch. The rotor of the wind turbine must stop again immediately, the power supply unit must deliver 5 A and the dumpload must heat up.
7. Your initial start-up procedure is finished. Remove the regulatory power supply and switch the main switch to **ON**.

 **The person who installs the machine or assembles it on the building is responsible for compliance with the instructions and the state of the art.**

 **Only use a regulated power supply for testing. Do NOT connect batteries or other power supplies for testing!**

 **Do not put the system into operation before all tests have been successfully completed! Document your results!**

Please note the instructions on the next page!



**⚠ Do not use more than 25 V or 5 A for the testing of your SkyWind wind turbine. The turbine can be damaged.**

**⚠ Perform all work, testing, maintenance only in good weather (below 2 Bft wind)!**

**⚠ Always check that no one is near the rotor before starting the turbine up or connecting the regulated power supply.**

**⚠ Only test the manual turning of the rotor with momentum while the system is safely switched off. Have a second person supervise that a start-up while you are on the roof is safely excluded!**

**⚠ If a complete initial start-up procedure can not be proven and documented all warranty is void!**

If you own a **SkyWind NG** battery charger version (12 or 24 V version), the test procedure is basically the same. Connect the laboratory power supply to the turbine cables at the charge controller input using suitable contacts. First check the direction of rotation at 5 V, then increase to 15, then to 25 V and check that the battery is charged. Then carry out the test of the storm shut-off as explained in 13.1 test point 3 and then of the main switch as

explained in 13.1 point 4. Since the DC-version does not have a dumpload, it is not necessary to test the heating of this.

At the end of all measures, the installer seals the system so that no changes can be made to the control system by the operator. Create a turbine logbook with which any subsequent changes and the person responsible for them can be traced.

### 13.2 FINE ADJUSTMENT/NOISE-REDUCED OPERATION

Every house is different, every location has different conditions and every person has a different perception of noise. Therefore, it may be that an installation that is actually the same works optimally for one person, but another still sees potential for optimization. In this case, you have the following options:







1. You can shut down the system at any time by using the OFF switch, thus bringing the rotor to a standstill. **NEVER do any changes to the wiring to shut the turbine down.**
2. As an accessory, you can install the noise control and set a wind speed at which you still find the turbine unobtrusive as the maximum operation speed. For example, set the sound setting to a

value of 36 km/h. The probability of higher wind speeds is often less than 1 %. The yield loss is thus small, but gust noise is avoided.

3. You can install a night control. In the simplest case, switch off the system at night using a timer. Or, if reduced operation at night is not a problem, install a timer that activates your noise control only at night.

### 13.3 DOCUMENTATION

After your turbine has successfully started operation, compile the documentation for the system, assembly and commissioning and archive all documents together in the log book provided. Print out the photos required there (structure, settings, electrics, etc.) and enclose them physically. Store the system logbook in an easily accessible place next to the system in case a technician needs to work on the system later. Remember that CDs and SD-cards can be lost or photos could be accidentally deleted later. In this case, you can no longer prove that the installation was correct and you will lose your warranty claim. It is therefore advisable to print out all documents, especially the photos.

- 
-  **Nobody must be near the turbine during testing and operation. Always stop the turbine before approaching it.**
  -  **Changes and maintenance on the system must be performed by trained professionals**
  -  **Only use a regulated power supply for testing. Do NOT connect batteries or other supplies, higher voltages etc. for testing!**
  -  **Do not use more than 25 V or 5 A for the testing of your SkyWind wind turbine. The turbine can be seriously damaged or destroyed by higher voltages or more power.**
  -  **Use suitable cables with banana plugs to connect the laboratory power supply.**
  -  **Always check that no one is near the rotor before starting the turbine up or connecting the regulated power supply.**
-

**⚠ Immediately shut the turbine down should you find your turbine or system is working abnormally or in case of any defects! Contact a trained professional to check or repair the turbine before continuing operation.**

**⚠ Contact your sales representative in case of any technical problems, missing parts or warranty claims. Standard warranty on SkyWind NG micro wind turbines is 36 month.**

**i Prepare a full set of documentation including pictures (with date in picture) of: nacelle installation, blades, power curve of the inverter, settings of the storm protection controller, setting of the time delay relay, the mechanical set-up, a result of the final test after installation. You will need to proof a correct installation to the manufacturer in case of a warranty claim!**

**i Should you find that your rotor is damaged by a storm or contact with debris etc. immediately stop the operation and replace the rotor. Due to the robust construction of the SkyWind a change of the nacelle is usually not required. However, if operation continues with an unbalanced rotor the entire generator will be defect within a short time!**

**i SkyWind Energy is liable for replacing a part under warranty but is not liable for de-/installation cost of any kind. It is in SkyWind Energy's sole responsibility to decide whether a repair or replacement is performed. If neither repair nor replacement is possible the buyer is limited to refund only.**





SkyWind NG  
Next Generation Windpower

SKYWIND NG MICRO WIND TURBINE SYSTEM

# Installation handbook for trained professionals

Version 6.0

*The installation must be done by trained professionals only! The installer must be qualified and accredited for work on AC-electrical installations. Expert knowledge and full understanding of the complete manual is mandatory! This handbook will provide a brief overview of the major steps.*



## 1. FIRST CHECK

- You will need an original **SkyWind NG** turbine including the automatic storm control from SkyWind Energy GmbH. If you are not sure whether your parts are original or not stop the installation and contact SkyWind.

- Your **SkyWind NG** turbine contains:

- a) Nacelle with generator installed

- b) 2x Patented SkyWind NG all-metal rotor blade

- c) Grid inverter including

- 1x SkyWind NG grid inverter with LCD-Display
- 1x Grid connection cable for grid inverter (*not depicted*)
- 2x Dump load resistor connection cable
- 2x Dump load resistor wall mount
- 1x Dump load resistor

- d) Automatic storm control including

- 1x Control Unit (GRV)
- 1x Time delay relay (GRT)
- 1x High current relay (JQX)

- Additionally you will need Solarflex®-X (or equivalent) 6 mm<sup>2</sup> cable, AC-cable (1.5 mm<sup>2</sup> recommendend), a spray can of under body protection wax for cars and Loctite® 243 glue. Other parts are also required, check the manual. Parts may depend on the type of tower and set-up.

- All parts must be checked for any visual damage. Only new and undamaged parts must be installed!

- Only trained professionals with extensive knowledge of the dangers of installation and operation may install and handle **SkyWind NG** turbines and accessories!



## 2. SITE AND CUSTOMER

- SkyWind NG turbines must be installed above all obstacles that might disrupt a free and continuous airflow. Remember the following rule: **BASIC RULE:** *When your head is at the height of the turbines nacelle you must not look into any trees, houses or other obstacles! You should see the horizon in any direction!*
- The turbines nacelle must, in any case, be mounted in a height of 10 m above the ground at least. **BASIC RULE:** *The closer a turbine is mounted to the ground, the more energy of the airstream will be lost due to ground friction. In most cases a turbine installed in 6 m height will generate only 20–40% of a turbine mounted at 10 m hub height at the same site.*
- When installed on a flat rooftop the hub height should also be about 1/3 of the buildings height or width (whatever is greater) above the building and at least 10 m above ground.
- A turbine should be mounted in the middle of a rooftop rather than on its edges.
- Individual turbines should be mounted in at least five (5) meters distance to each other.
- Turbulence created by nearby trees, other buildings etc. may cause disruption of airflow. This can cause the turbine to be destroyed and must be avoided (see picture).

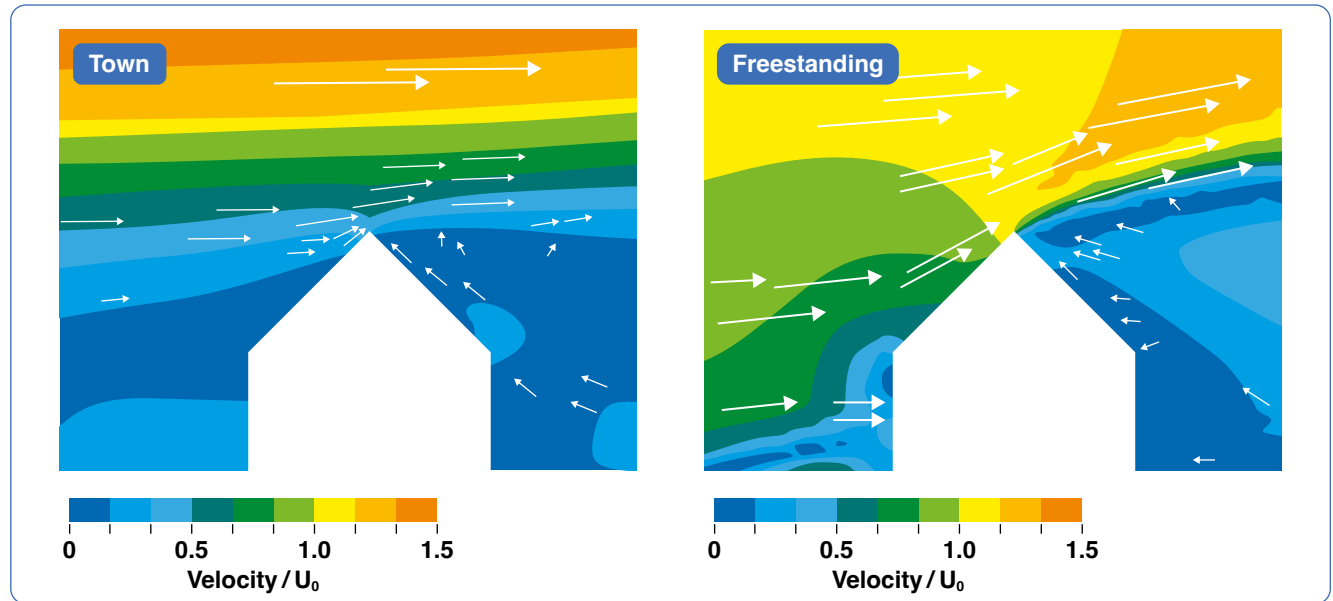
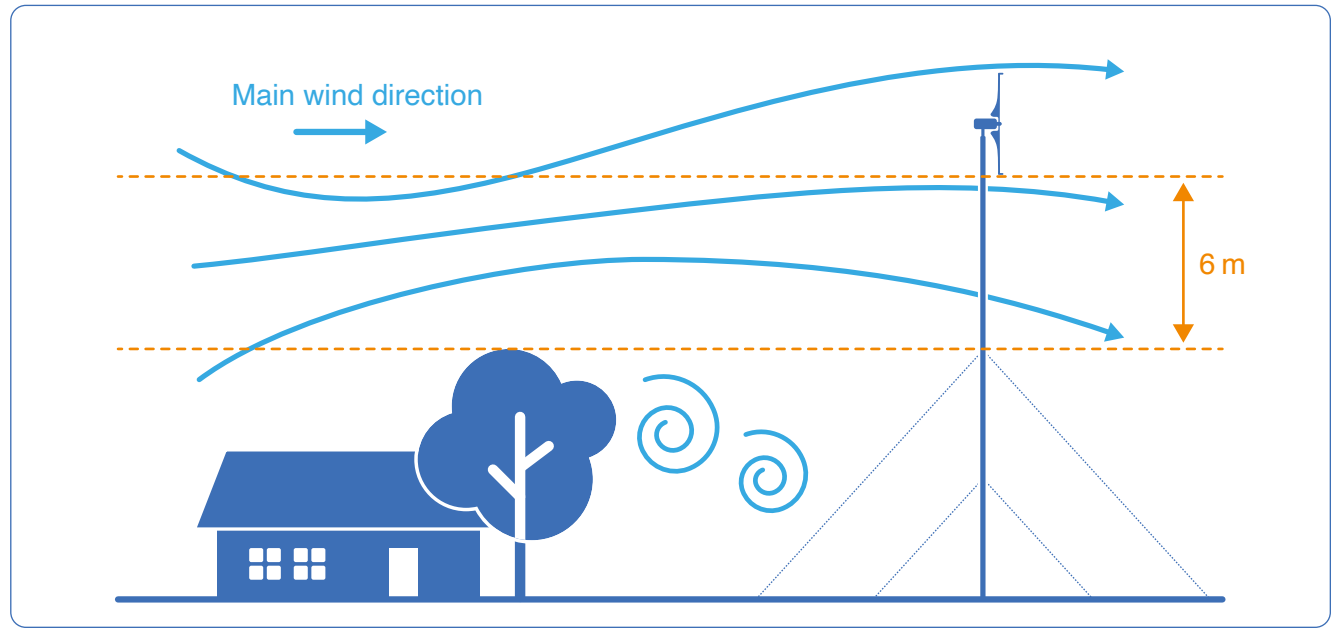

Source: Centre for Renewable Energy Systems Technology (CREST), Loughborough University

## 3. VISUAL CHECK



Place the system at an angle as shown!

- Place the turbine as shown in the picture. Do not place the turbine on the back. This would lead to the metal deforming once the cover is removed.
- Check the turbine for any potential visual damages, bend parts etc.
- Check the generator by turning its shaft by hand. Check the generator by connecting it to a 25 V DC-power source. The generator should consume about 0.65 A after a 10 minute test run.
- Check that all parts needed for the installation are available.

- Any visual damage on the turbines packaging must be reported to the shipper immediately upon receiving the package! Any damage of the turbine itself (not visible from the outside) or missing parts must be reported within five (5) days after receiving!

**ADVICE:** After removing the nacelle cover you will see the main generator inside. On the generator you will find a small rectangular shaped area with insulation and without coating. This is normal, you are not missing any parts.

## 4. OPENING THE GENERATOR



- Mark the side of the nacelles cover which is facing the shaft. Only in this direction the cover will fit to the turbine again after dismounting.
- Open up the nacelle by loosening all the screws highlighted in yellow and remove the nacelle cover. **Keep the turbine in the position shown under Fig. 1.**



## 5. NACELLE CABLE CONNECTION

- Measure up **6 mm<sup>2</sup> Solarflex-X PV1 X cable** so that the length will be sufficient from turbine to the inverter. The DC-cable should not be longer than 20m. Check the manual for details on cross-sections.
- Lead the cable from the down end of the mast adapter into the nacelle (A – orange). **Please note that the generator must not be dismantled to do so!**
- Lead one cable left to the generator, one cable to the right of the generator (B – green) towards the generators connection cables. Apply plenty of grease to the upper end of the mast adapter (A – orange).

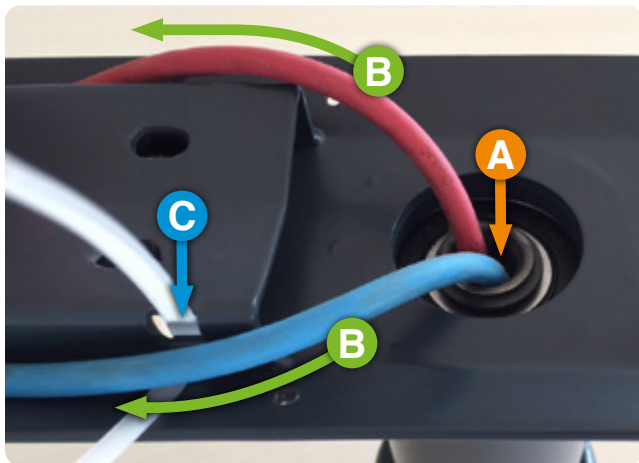
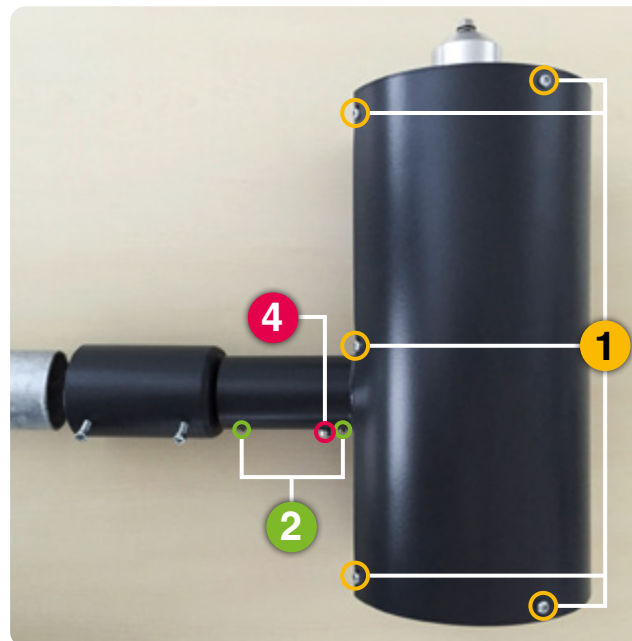

Image is for illustration purposes only.  
**DO NOT remove the generator!**

- Connect the generator cables to the DC-cables using shrink-insulated crimp connectors.
- Fix the cables to the nacelle using four zip-ties at the dedicated wholes in the nacelle (C – blue).
- Check that the generator is bolted down very tightly to the nacelle.

## 6. NACELLE FINALIZATION



- Mount the nacelle cover again using the screws marked in yellow. Fix the yellow (1) screws with 2 Nm torque and Loctite® 243.

- During installation the turbines yaw-axis can be locked to make installation easier and safer. This can be done by tightening the yaw-lock screw (4 – red). Before the turbine can begin operation this screw has to be loosened so that half its length is outside the turbine. After installation fix the screw in position using Loctite® 243.
- The bearing-lockers should be checked (2 – green). If these are too tight the turbine won't be able to yaw correctly. If these are too loose the turbines operation might be louder than expected. Check manual for details.

## 7. MOUNTING PREPARATION

- Attach a fitting ring terminal to the end of your DC-cable to ensure easy and quick connection to the inverter later on. If you use more than a single cable make sure that the connection is safe and durable (e.g. MC connectors). **Mark the + and the – pole clearly and unmistakably!**



- **Keep in mind: no cable connections inside the tower.**
- The turbine nacelle is now prepared for mounting on a suitable mast.
- Write down the serial number of the SkyWind turbine (see blue circle). You might later need it in case of a warranty claim.

## 8. ELECTRICAL INSTALLATION

- Lay all necessary DC-cabling before the next steps of installation except the last meters from the turbine (top end of tower) to the lower end of the tower (it is useful to make a connection there). Prepare necessary cable ducts.
- The electrical connection according to the wiring diagram. Check the manual for the details.
- The automatic storm control system according to the wiring diagram. **Set the control unit and time delay relay to the correct settings. Check the manual!**
- Install an AC-switch with control of the power supply of the entire wind turbine (inverter + storm control). This switch can be used as the main switch later.
- Make yourself familiar with how the electric system is supposed to work. A mistake during the installation can lead to destruction of the wind turbine.



## 10. DC-INSTALLATION OF THE INVERTER

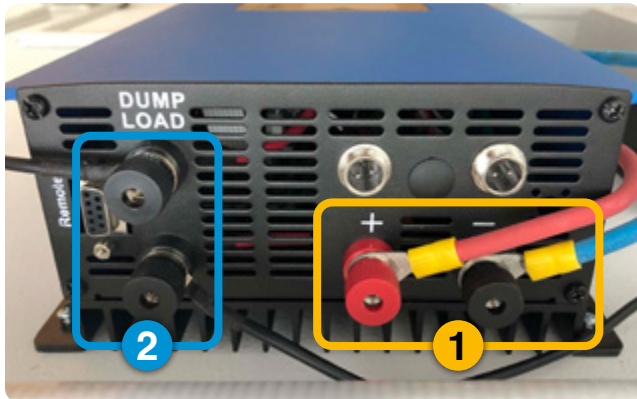

- Connect the inverter to the turbine using the far right red + and black – connectors labeled with “DC-INPUT” (1 – yellow). Make sure that the polarity is correct!
- Mount the dumpload close to the inverter, but not below it. In case of too much power the resistor might become very hot. **Do not mount it onto flammable surfaces and use the mounts delivered with your turbine.**
- Connect the dumpload to the connectors labeled “DUMPLOAD” (2 – blue). There is **no** polarity to check with the dumpload.
- Do install only the inverter directly to a conducting surface, but not the dumpload! If you use a metallic plate for mounting the dumpload a sufficient insulation between the dumpload-mounts and the conducting surface must be installed!

## 11. AC-INSTALLATION OF THE INVERTER



- Connect the inverter to the AC-grid using the “AC-OUTPUT” connector. Some countries legislation (e.g. Germany) may require to glue this plug into place.
- The inverter must be installed in a suitable place without fluid or condensating water or extreme temperatures.
- Strictly follow the wiring diagram and manual.

## 12. SETTING UP THE ONBOARD COMPUTER



- A proper set-up of the SkyWind’s inverter computer is vital to a safe and reliable operation of your wind turbine. Follow the manual on which power curve to choose and how to set it up correctly.
- Carefully follow the instructions and manual to make sure your turbine and storm control is set-up properly. In case of any doubt contact your SkyWind representative.
- Document all settings of your storm control system and of your inverter by taking pictures. Without photographic documentation your warranty is void.

## 13. FINALIZING THE ELECTRICAL INSTALLATION



- Check the whole electrical installation and write down your wiring diagram to check yourself.
- Document all settings of your storm control system and of your inverter by taking pictures with visible dates. Without photographic documentation your warranty is void.
- Set the turbines main switch to OFF. Install a sign on the main switch that it may only be used every 60 minutes to prevent generator damage.

- The inverter will work on standard 230 V and 110 V AC-grids. The inverters are suitable for the SkyWind only. However the storm control is suitable for 230 V AC-grids only. You will need to use a small transformer to power the storm control in a 110 V AC-grid.

**⚠ DO NOT INSTALL THE DUMPLoad DIRECTLY ON A CONDUCTIVE SURFACE (e.g. metal). Use plastic screws and suitable insulation between mounts and surface to prevent conductive connection between the dump-load-mounts and the mounting surface.**

- Choose a matching tower according to the manual. The tower must at least:

1. Withstand a thrust force of the turbine of **750 N**.
2. The tower top must not deflect more than **1°** from the vertical under 50 % load.
3. The tower resonance frequencies must not be between **10–50 Hz**.
4. The tower top meter must have a diameter of **59–61 mm**.
5. The tower top must exceed the height of the surrounding trees, buildings etc.

*A wall thickness of at least 3 mm is mandatory. Only steel towers should be used. Guy wires may be used if needed.*

## 14. CHOOSING A SUITABLE TOWER

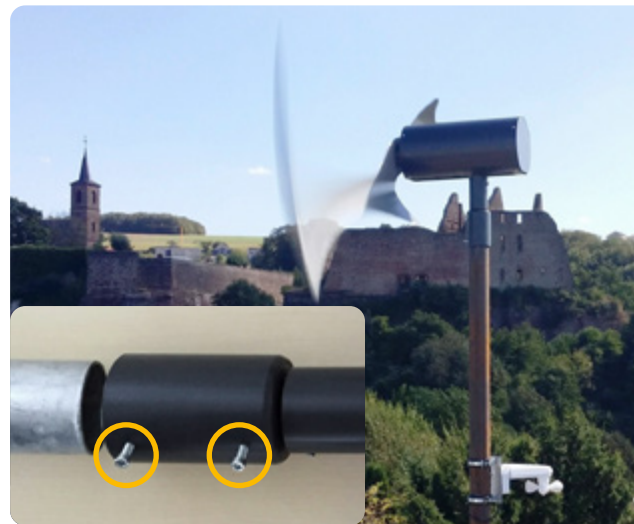

- Firmly and **evenly** tighten the two turbine securing screws (yellow markings). Make sure that both screws are evenly tightened and glued in place with Loctite® 243. The nacelle must be fixed in an absolutely parallel position to the ground. The tower must be perfectly vertical ( $\pm 0,2^\circ$ ).

## 15. INSTALLING THE BLADE

- Check that the turbine systems main switch is in **OFF position**. This way the turbine can not start up after installation of the rotor blade.
- Install the patented SkyWind rotor blade as the last part of the installation. The blade is made of two pieces. **You must align the rotor blades perfectly above each other. Read page 23 of the manual!**

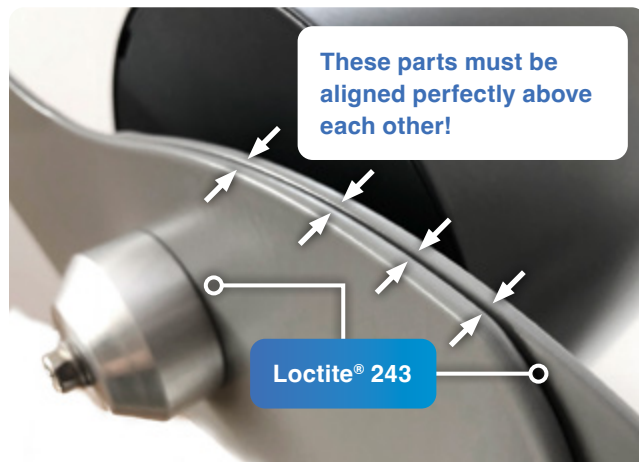

Make sure to align the edges of the rotor blades perfectly on top of each other! Be very precise!

- After installation of the blades between the two precision made aluminum cones, the single fixing screw is tightened until the lock ring is pressed flat. This rotor fixing screw must be fixed with a torque of 15 Nm and secured with Loctite® 243 as seen on page 23!

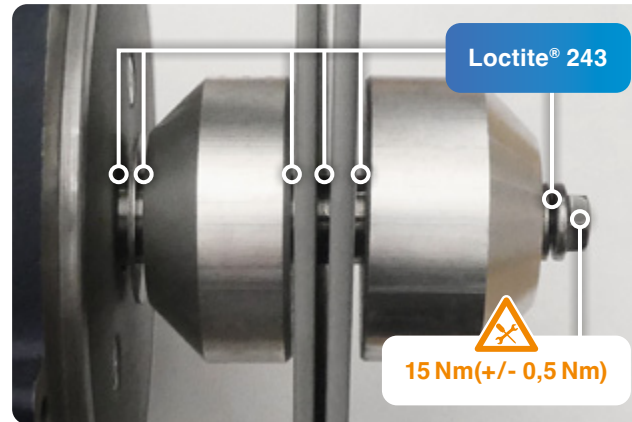

Use the correct order when installing the parts of the rotor blade. Be very precise!

- Cover every part of the turbine nacelle and mast adaptor with a **protective wax** (e.g. Liqui Moly Art. No. 6103) after installation. For coastal sites with salty air this must be done inside the turbine nacelle as well. The rotor must not be covered.

The turbine may now be started up for the first time. The start up speed will decrease considerably within the first 100 hours of operation under load.

## 16. FINAL TESTING

It is mandatory to perform a general function test after finishing the installation.

- Check that the installation has been performed correctly as mandated by this manual.
- Follow every test-step as detailed on page 49–50 of this manual.
- **Document the installation and your test results in the log book!**

Do not connect a battery or any other power source to the turbine or inverter as these provide high shock currents. This might loosen the screw fixing the rotor or damage the generator.

**THE INSTALLATION IS NOW COMPLETED.**



## DECLARATION OF CONFORMITY

SkyWind Energy GmbH  
 Bayernstrasse 3  
 30855 Langenhagen  
 Germany  
 www.myskywind.com | post@myskywind.com

<b>EU conformity declaration</b> SkyWind NG Micro Wind Turbine	<b>SkyWind NG</b> Next Generation Windpower
<b>Manufacturer</b>	<b>SkyWind Energy GmbH</b>
Type, Product Name	Micro Wind Turbine (<math>2\text{ m}^2</math>), SkyWind NG
Serial-No. Covered By This Document:	SWNG 1000 5000 or higher (e.g. SWNG 1000 12345)
Specification	Rotor Diameter: 1,50 m Weight: 19 kg excl. accessories Voltage: 60 V DC   230/110 V AC
EU-Directive(s)	2006/42/EG <i>Machinery Directive</i>  Regulation (EU) No. 305/2011 <i>Construction Products Regulation</i>  2014/30/EU <i>EMC Directive</i>  2014/35/EU <i>Low Voltage Directive</i>

The product is manufactured in accordance with the named directives as well as the relevant regulations of the EN IEC 61000-6-1:2019, EN 61000-6-3:2007+A1:2011+AC:2012, EN62109-1:2010, EN 62109-2:2011, VDE-AR-N 4105:2018-11, EN 61400-2:2014.

This declaration is valid for all specified copies of the product. The declaration is void if the product has been modified. The declaration is void if product is not installed in accordance with the products manual and the relevant technical standards. The CE symbol and serial number is attached to each copy of the product. The micro wind turbine and accessories must be installed, maintained and operated by trained professionals only (§434 I 1, German Civil Code & EN 61400-2).

The product manual is constituent part of this declaration.

**The product complies with all applicable essential requirements of the directives.**

Engineering Representative: Fritz Unger, Lehrter Strasse 62, 30559 Hannover, Germany  
 We, SkyWind Energy GmbH, declare the sole responsibility.

SkyWind Energy GmbH  
 Bayernstr. 3, 30855 Langenhagen  
 Fon +49 (0) 511 444 572 45  
 post@myskywind.com  
 www.myskywind.com

Hannover, Germany on the 15th of Dec. 2023	SkyWind Energy GmbH
--	---------------------

### Unit Certificate Einheitszertifikat

No. 26210383-A-M1-CERE1

**By the product certificate number / Durch die Produktzertifikatsnummer**  
 Issued to / Lautend auf:  
 License holder / Lizenzinhaber: SHANGHAI TINGEN ELECTRIC CO.,LTD  
 NO.602,Lane3118,Yindu Road,Minhang District,Shanghai City,China

**Trademark / Warenzeichen**: TINGEN

**Contract number / Vertragsnummer**: 801668

**It is certified that the product / Es ist zertifiziert, dass das Produkt:**

**Type of generator / Generatorart**: Grid-Grid Power Inverter

**Models / Modelle**: SUN-1000G2-H / SUN-1000G2-M / TEG-1000G-WAL / TEG-1000G-WDL / SUN-2000G2 / TEG-2000G-WAL / TEG-2000G-WDL

**Technical Data / Technische Daten**:  
 Rated AC Power / AC-Nennleistung  
 Rated AC Voltage / Nennwechselspannung  
 Rated Frequency / Nennfrequenz  
 DC Current (IN / OUT) / DC Strom (IN / OUT)  
 Initial short-circuit current / Anfänglicher Kurzschluss  
 Wechselstrom  
 Firmware version / Firmware Version  
 Number of phases / Anzahl der Phasen  
 Isolation transformer / Isolationstransformator

See page 2 / Siehe Seite 2

See page 2 / Siehe Seite 2

50 / 60 Hz

See page 2 / Siehe Seite 2

See page 2 / Siehe Seite 2

Ver.1

Three Phases / Dreiströmenstr

No / Nicht

**Is in compliance with the Network connection rule: / In Übereinstimmung mit der Netzwerkverbindung Regel:**

- VDE-AR-N 4105: 2018-11.  
 "Generators connected to the low-voltage distribution network / Erzeugungsanlagen am Niederspannungsnetz"  
 Technical minimum requirements for connection and parallel operation of power generation systems connected to the low-voltage network / Technische Mindestanforderungen für Anschluss und Parallelbetrieb von Erzeugungsanlagen am Niederspannungsnetz

**Based on tests requirements defined in: / Basierend auf Tests Anforderungen definiert in:**

- DIN VDE V 0124-100 (VDE V 0124-100): 2020-06.  
 "Network integration of power generation systems - Low voltage / Netzintegration von Erzeugungsanlagen"  
 Test requirements for power generation units intended for connection to and parallel operation on the low-voltage network / Testanforderungen an Erzeugungsanlagen, vorgesehen zum Anschluss und Parallelbetrieb am Niederspannungsnetz

This certificate is based upon test results offered in the test report no. BL-DG2190272-801 issued on 20<sup>th</sup> December 2021. / Dieses Zertifikat basiert auf den Testergebnissen, die im Prüfbericht Nr. BL-DG2190272-801, herausgegeben am: 20. Dezember 2021.

The above-mentioned generating unit is certified according to the SGS internal procedure PE.T-ECPE-13 based on the requirements of the UNE-EN ISO / IEC 17065 / Die oben genannte Erzeugungseinheit ist gemäß dem internen SGS-Verfahren PE.T-ECPE-13 basierend auf den Anforderungen der UNE-EN ISO / IEC 17065 zertifiziert.

This certificate cancels and supersedes the certificate no. 26210383-A-M1-CER / Dieses Zertifikat annulliert und ersetzt das Zertifikat Nr. 26210383-A-M1-CER

First issued on 14<sup>th</sup> March 2022 / Zuerst veröffentlicht am: 14. März 2022.  
 This certificate is valid until 22<sup>nd</sup> February 2027. / Zuerst veröffentlicht am: 22. Februar 2027.

**Madrid, 16<sup>th</sup> March 2022 / Madrid, 16. März 2022**

Daniel Amoriz Muritz  
 Certification Manager

SGS Tecos, S.A. Ci Trepatolme, 29 - 28042 Madrid  
 This certificate is issued by SGS under its General Conditions for Product Certification at [www.sgs.com/terms\\_and\\_conditions](http://www.sgs.com/terms_and_conditions)  
 The status and validity of the certificate can be checked scanning the QR code above included or through the following web link database:  
<http://www.sgs.com/product-certificates-and-producttechnical-products>  
 This document cannot be reproduced partially.

No. 26210383-A-M1-CERE1  
Page 1 of 4



**INSTRUCTION FOR REGIONS WITH  
HURRICANES, TYPHOONS OR OTHER EXTREME WIND EVENTS:**

**Dismount the rotor or tilt the tower before a Hurricane –  
no wind turbine design is able to withstand the extreme forces of such events!**

---

This document represents the interpretation of the original document **Bedienungsanleitung, Version 6.0** which may be found online at <http://myskywind.com/> and was made to the best knowledge of the interpreter. Only the original document is legally binding.



SkyWind NG  
Next Generation Windpower

We hope you enjoy your micro wind turbine.  
Thank you for choosing the **SkyWind NG!**

**Happy with your turbine?**

We would be glad to receive feedback or a picture of your project!  
Mail to: [post@myskywind.com](mailto:post@myskywind.com)

We care about your feedback. The best projects and pictures might be published on our 60.000+ Facebook page and receive a thank you package!

**SkyWind Energy GmbH** | Bayernstrasse 3, 30855 Langenhagen, Germany | [www.myskywind.com](http://www.myskywind.com)

Layout and design: Lisa Doß (ldoss-design.de), contains vector graphics designed by Freepik







SkyWind NG  
Next Generation Windpower

## Protokollbuch

Ihrer SkyWind NG  
Mikrowindkraftanlage



Zur Dokumentation der Erfüllung der Vorgaben entsprechend 9. VO zum ProdSG i.V.m. RL 2006/42/EG, sowie Dokumentationspflicht entsprechend DIN EN 61400-2 Ziff. 11.2.5.3 und Beschaffenheitsvereinbarung SkyWind NG gemäß §434 I Abs. 1 BGB.

Version 1.2 1/25  
39BjT\_RyS

# INHALTSVERZEICHNIS

Seite	Inhalt
Seite 2	Inhaltsverzeichnis
Seite 3	Einführung
Seite 4 - 14	Installations- & Anlagenprotokoll
Seite 15 - 22	Fotografische Dokumentation
Seite 23 - 24	Anlagenschaltplan & Gesamtaufbau
Seite 25 - 26	Sturmprotokoll
Seite 27	Inspektionsprotokoll, Modifikations- & Reparaturprotokoll

Bitte bewahren Sie dieses Protokollbuch und die Bedienungsanleitung Ihres SkyWind NG immer gemeinsam auf. Achten Sie auf Veröffentlichungen der SkyWind Energy GmbH. Falls eine neue Version der Bedienungsanleitung veröffentlicht wird legen Sie diese, am besten ausgedruckt, zu Ihren Unterlagen.

Ihre Windkraftanlage ist im Betrieb den freien Elementen ausgesetzt. Daher ist es wichtig sie, gemäß den Vorgaben der Bedienungsanleitung, zu prüfen und insbesondere nach Stürmen auf Schäden zu prüfen. Fällt ein über das Dach in die Windkraftanlage geflogenes Trampolin aus der Nachbarschaft noch relativ leicht auf, sind Astschläge oder Schäden durch extremen Hagel nicht auf den ersten Blick offensichtlich. Prüfen Sie Ihre Anlage daher nach starken Stürmen, insbesondere auf Schäden am Rotor, und dokumentieren Sie Ihre Ergebnis. Tauschen Sie die Rotoren falls erforderlich sofort um Folgeschäden zu vermeiden. Ersatzteile erhalten Sie jederzeit bei SkyWind Energy.

Die Bearbeitung von Reklamationen, sowie Gewährleistungs- und Garantieansprüchen ist ausschließlich nach vollständiger, wahrheitsgemäßer Übermittlung dieses Protokollbuches und der erforderlichen Anlagen möglich. Gemäß Leitfa-den für die Anwendung der Maschinenrichtlinie 2006/42/EG der Europäischen Kommission §37, sind die erforderlichen Prüfungen und Inspektionen durch den Inbetriebnehmer an der auf Ihrer tragenden Konstruktion montierten Maschine durchzuführen und die Erfüllung der Sicherheitsvorschriften dort zu überprüfen. Derjenige der die Maschine aufbaut oder an dem Gebäude montiert ist für die Einhaltung der Anleitung sowie des Stands der Technik verantwortlich. Es wird darauf hingewiesen, dass die EG-Konformitätserklärung und das auf der Windkraftanlage aufgebrachte CE-Kennzeichen nur bei bedienungsanleitungskonformer Installation, Inbetriebnahme und Betrieb gültig sind und mit falschen oder fehlenden Angaben in diesem Protokollbuch ungültig werden. Die Inbetriebnahme einer Anlage ohne CE-Kennzeichen ist gesetzlich verboten.

# PROTOKOLLBUCH

Mikrowindkraftanlage SkyWind NG

## HERZLICHEN GLÜCKWUNSCH!

Vielen Dank, dass Sie sich für Ihre ganz persönliche Mikrowindkraftanlage entschieden haben! Bereits über 10.000 Kunden weltweit setzen dafür wie Sie auf unseren SkyWind NG.

## Was ist das Protokollbuch?

Das Protokollbuch ist die gemäß DIN EN 61400-2:2014 und unserer Beschaffenheitsvereinbarung sowie Bedienungsanleitung vorgesehene Dokumentation jeder kleinen Windkraftanlage. Verstehen Sie es als den **Steckbrief Ihrer Windkraftanlage**. In Ihrem Protokollbuch werden alle wesentlichen Einstellungen, Ereignisse und Parameter Ihrer Windkraftanlage aufgezeichnet. Legen Sie es insbesondere auch jedem Handwerker, der an Ihrer Anlage arbeitet vor, damit er die Einträge zu seiner jeweiligen Tätigkeit machen kann.

## Warum ein Protokollbuch?

Ihre Windkraftanlage ist dafür entwickelt viele Jahre umweltfreundliche Energie zu erzeugen. Mit diesem Buch kann auch ein Handwerker der in zehn Jahren an Ihrem Haus arbeitet den gesamten Aufbau und die Servicehistorie Ihrer Anlage nachvollziehen. Denn oft kommt dann ein anderer Betrieb, oder der Mitarbeiter, der Ihre Anlage errichtete erinnert sich nicht mehr an wichtige Einstellungen. Dafür ist es wichtig eine zentrale Stelle mit allen relevanten Informationen zu Ihrer Windkraftanlage zu besitzen. Falls einmal ein Problem auftreten sollte, hat der beauftragte Techniker auch dann schnell einen Überblick über Aufbau, Funktion und die Einstellungen Ihrer Maschine. Falls Sie eine Versicherung für Ihre Windkraftanlage abgeschlossen haben, oder eine Versicherung für das Gebäude halten, deren Police die Windkraftanlage mitabdeckt, benötigen Sie dieses Protokollbuch außerdem im Falle eines Schadens, um die Versicherung in Anspruch nehmen zu können. Darum ist es wichtig diese Dokumentation stets aktuell und griffbereit zu halten.

## Wichtiger Hinweis

Bitte beachten Sie, dass jeder, der Arbeiten oder Überprüfungen an einer Windkraftanlage vornimmt dafür unbedingt die Bedienungsanleitung in ihrer jeweils aktuellen Form kennen muss. Dort finden Sie Hinweise zu den abgefragten Aspekten, vorgegebene Einstellwerte ebenso wie wichtige Gefahrenhinweise. Zögern Sie nicht bei Fragen oder Unklarheiten Ihren Betrieb oder den Hersteller zu kontaktieren.

Ihr Kontakt zu uns für alle technischen Anfragen:

[service@myskywind.com](mailto:service@myskywind.com)

# Protokoll Ihrer SkyWind NG Installation

Gemäß Beschaffenheitsvereinbarung §434 I 1 BGB, Richtlinie 2006/42/EG & DIN EN 61400-2:2014

*Vollständig ausgefüllt für jede Anlage abzulegen. Unzutreffendes durch Streichen zu entwerten.*

## Teilbereich I - Vertragsdaten

1.01	Seriennummer Windkraftanlage		
1.02	Auftragsdatum		
1.03	Auftragsnummer SkyWind		
1.04	Datum der Erstinbetriebnahme		
1.05	Kunde	Nachname	
1.06		Vorname	
1.07		Strasse, Nr.	
1.08		PLZ, Ort	
1.09		Land	
1.10		Firma	
1.11		eMail	
1.12	Betreiber	Nachname	
1.13		Vorname	
1.14		Strasse, Nr.	
1.15		PLZ, Ort	
1.16		Land	
1.17		eMail	

## Teilbereich II - Standortdaten der Anlage

2.01	Standort	Strasse, Nr.	
2.02		PLZ, Ort	
2.03		Land	
		Geo. Koordinaten Länge	°
2.05		Geo. Koordinaten Breite	°
2.06		Höhe NN	m

2.07	Anlage gebraucht gekauft	<input type="radio"/>	Ja	<input type="radio"/>	Nein
2.08	Erster Anlagenstandort oder bereits umgebaut	<input type="radio"/>	Erster	<input type="radio"/>	Umgebaut
2.09	Vorheriger Standort (Falls vorhanden)	Strasse, Nr.			
2.10		PLZ, Ort			
2.11		Land			
		Geo. Koordinaten Länge	°		
2.13		Geo. Koordinaten Breite	°		
2.14	Höhe NN	m			
<b>Angaben zum aktuellen Standort</b>					
2.15	Nabenhöhe über Erdboden				m
2.16	Hanglage	<input type="radio"/>	Ja	<input type="radio"/>	Nein
2.17	Wenn ja - Mittlere Hangneigung				°
2.18	Standort vor Montage auf Eignung geprüft	<input type="radio"/>	Ja	<input type="radio"/>	Nein
2.19	Standortprüfung/einschätzung durch				
2.20	Standortcharakter: Freifläche	<input type="radio"/>	Ja	<input type="radio"/>	Nein
2.21	Standortcharakter: Direkter Ortsrand	<input type="radio"/>	Ja	<input type="radio"/>	Nein
2.22	Standortcharakter: In bebautem Gebiet	<input type="radio"/>	Ja	<input type="radio"/>	Nein
2.23	Höhe des höchsten Hindernisses <10 m Abstand				m
2.24	Höhe des höchsten Hindernisses <25 m Abstand				m
2.25	Höhe des höchsten Hindernisses >25 m   <100 m				m
2.26	Anzahl der Hindernisse >6 m Höhe bis 50 m Abstand				
2.27	Anzahl Hindernisse in Nabenhöhe				
	Mittlere Windgeschwindigkeit lt. Windatlas				m/s in 10 m Höhe

### Teilbereich III - Ausführende Betriebe / Geschultes Personal

3.01	Elektrik	Firma			
3.02		Strasse, Nr.			
3.03		PLZ, Ort			
3.04		Land			

3.05

Website

3.06

Telefon

3.07

eMail

3.08

Verantwortlicher Elektriker

Vorname

3.09

Nachname

3.10

Datum der Fertigstellung

3.11

Dach/Mast

Firma

3.12

Strasse, Nr.

3.13

PLZ, Ort

3.14

Land

3.15

Website

3.16

Telefon

3.17

eMail

3.18

Verantwortlicher Monteur

Vorname

3.19

Nachname

3.20

Datum der Fertigstellung

3.21

Projektierer

Firma

3.22

wenn vorhanden

Strasse, Nr.

3.23

PLZ, Ort

3.24

Land

3.25

Website

3.26

Telefon

3.27

eMail

3.28

Verantwortlicher Projektierer

Vorname

3.29

Nachname

3.30

Datum der Fertigstellung

### Teilbereich IV - Mast & Mastmontage

4.01	Art der Montage	<input type="radio"/> Freistehend	<input type="radio"/> Dach	<input type="radio"/> Anderes
4.02	Aufdach-Set SkyWind verwendet	<input type="radio"/> Ja	<input type="radio"/> Nein	
4.03	Flanschmontage-Set SkyWind verwendet	<input type="radio"/> Ja	<input type="radio"/> Nein	
4.04	Eigenes Mastsystem	<input type="radio"/> Ja	<input type="radio"/> Nein	

#### IV a) Wenn Aufdach-Set "JA"

4.05	Baujahr Haus			
4.06	Montage baustatisch geprüft	<input type="radio"/> Ja	<input type="radio"/> Nein	
4.07	Dynamische Lasten/Vibration geprüft	<input type="radio"/> Ja	<input type="radio"/> Nein	
Wenn "JA" bitte jeweils Statik und Berechnung beifügen.				
4.08	Abstand Rotorkreisunterkante zu Oberkante Dachfirst			cm
4.09	Dachneigung			°
4.10	Firstausrichtung (bsp. Nordwest - Südost)			
4.11	Bauteile unverändert eingebaut? (zB Mast verlängert)	<input type="radio"/> Ja	<input type="radio"/> Nein	
4.12	Was wurde verändert?			
4.13	Abspannung vorhanden	<input type="radio"/> Ja	<input type="radio"/> Nein	
Wenn "JA" bitte Zeichnung und Detailangaben zur Anzahl der Seile, Seiltyp/Querschnitt/Seilspannern beifügen				
4.14	Dämmung im Dach vorhanden	<input type="radio"/> Ja	<input type="radio"/> Nein	
4.15	Drehmoment zentrale Mastbefestigungsmutter			
4.16	Verschalung im Dach vorhanden	<input type="radio"/> Ja	<input type="radio"/> Nein	
4.17	Materialtyp und Stärke Verschalung			
4.18	Montage Unterziegel	<input type="radio"/> Ja	<input type="radio"/> Nein	
4.19	Montage Über-Dach auf Profilschiene	<input type="radio"/> Ja	<input type="radio"/> Nein	
4.20	Typ, Material Dachhaken			
4.21	Typ, Material, Format Profilschiene			
4.22	Montage Dämpfer/Dachhaken auf Verschalung	<input type="radio"/> Ja	<input type="radio"/> Nein	

4.23	Montage Dämpfer/Dachhaken auf Lattung	<input type="radio"/>	Ja	<input type="radio"/>	Nein
4.24	Montage Dämpfer/Dachhaken auf Sparren	<input type="radio"/>	Ja	<input type="radio"/>	Nein
4.25	Maße und Materialart der Lattung				
4.26	Maße und Materialart der Sparren				
4.27	Schraubentyp Dachhaken zu Untergrund				
4.28	Schraubentyp Dämpfer zu Untergrund				
Detailfoto der installierten Dämpfer beifügen.					

#### IV b) Wenn Flanschmontage-Set "JA"

4.29	Baujahr Wand				
4.30	Montage baustatisch geprüft	<input type="radio"/>	Ja	<input type="radio"/>	Nein
4.31	Hinsichtlich dynamischer Lasten/Vibration geprüft	<input type="radio"/>	Ja	<input type="radio"/>	Nein
*Wenn "JA" bitte Statik und Berechnung beifügen.					
4.32	Bauteile verändert eingebaut? (z.B. Mast verlängert)	<input type="radio"/>	Ja	<input type="radio"/>	Nein
4.33	Was wurde verändert?	<input type="radio"/>	Ja	<input type="radio"/>	Nein
4.34	Abstand zwischen höchstem Punkt Dach und Rotornabe				m
4.35	Abspannung verwendet?	<input type="radio"/>	Ja	<input type="radio"/>	Nein
Wenn "JA" bitte Zeichnung und Detailangaben zur Anzahl der Seile, Seiltyp/Querschnitt/Seilspannern beifügen					
4.36	Anbringung an (z.B. Giebel, Fahrstuhlschacht, Fassade etc.)				
4.37	Gebäudebreite				m
4.38	Gebäudelänge				m
4.39	Material der Wand (z.B. Beton/Holz/Mauerwerk)				
4.40	Wandstärke/Bauart				
4.41	Befestigungsart der Dämpfer				
Detailfoto der installierten Dämpfer beifügen.					
4.42	Daten Befestigungsmaterial (z.B. Schraubentyp/Maße)				
4.43	Abstandshalter zwischen Wand und Dämpfern?	<input type="radio"/>	Ja	<input type="radio"/>	Nein
Wenn "JA" bitte Zeichnung beifügen.					



4.44	Überbrückter Abstand (z.B. wg. Dachüberstand)	
4.45	Material des Abstandshalters	

#### IV c) Wenn Anderes/Eigenes Mastsystem "JA"

4.46	Montage auf einem Dach?	<input type="radio"/> Ja	<input type="radio"/> Nein
4.47	Montage auf einem Objekt? (z.B. Antenne/Baum)	<input type="radio"/> Ja	<input type="radio"/> Nein
4.48	Freistehende Montage auf einem Mast?	<input type="radio"/> Ja	<input type="radio"/> Nein
Detaillierte Zeichnung des Mastsystems beifügen.			
4.49	Montage baustatisch geprüft	<input type="radio"/> Ja	<input type="radio"/> Nein
4.50	Hinsichtlich dynamischer Lasten/Vibration geprüft	<input type="radio"/> Ja	<input type="radio"/> Nein
Wenn "JA" bitte Statik und Berechnung beifügen.			
4.51	Material Mast		
4.52	Länge Mast		m
4.53	Bauform Mastrohr (zB konisch/zylindrisch etc.)		
4.54	Wandstärke Mastspitze	mm	
4.55	Wandstärke Mastmitte	mm	
4.56	Wandstärke Mastfuß	mm	
4.57	Durchmesser Mastspitze	mm	
4.58	Durchmesser Mastmitte	mm	
4.59	Durchmesser Mastfuß	mm	
4.60	Abspannung vorhanden	<input type="radio"/> Ja	<input type="radio"/> Nein
Zeichnung und Detailangaben zur Anzahl der Seile, Seiltyp/Querschnitt/Seilspannern beifügen			
4.61	Fundament-Typ (wenn vorhanden)		
4.62	Fundament-Bauart (wenn vorhanden)		
4.63	Fundament-Material (wenn vorhanden)		
4.64	Fundamentgröße (wenn vorhanden)		
4.65	Bodenart (bei Fundamentbau)		

4.66	Entkopplung eingebaut	<input type="radio"/> Ja	<input type="radio"/> Nein
4.67	Entkopplertyp und Anzahl		
4.68	Höhe Entkoppler 1 (vom Mastfuß aus betrachtet)	m	
4.69	Höhe Entkoppler 2 (vom Mastfuß aus betrachtet)	m	
4.70	Höhe Entkoppler 3 (vom Mastfuß aus betrachtet)	m	
Wenn "Ja" Detailfoto der installierten Dämpfer beifügen.			
4.71	Maximale Auslenkung Mastspitze bei 100% Last	cm	
4.72	Maximale Auslenkung Mastspitze bei 100% Last	°	
4.73	1. 2. 3. 4. Harmonische Eigenfrequenz Mastsystem	Hz	
*Die statische und dynamische Berechnung ist beizulegen.			

**Teilbereich V - Elektrischer Anschluss**  
Fügen Sie einen vollständigen Schaltplan der Anlage bei.

5.01	Tag der Montage		
5.02	Anlagentyp	<input type="radio"/> AC	<input type="radio"/> 24 V DC <input type="radio"/> 12 V DC
5.03	Maximale Böen am Montagetag	km/h	
5.04	Kabeltyp DC		
5.05	Kabelhersteller DC-Kabel		
5.06	Kabellänge DC Generator bis Sturmabschaltung	m	
5.07	Leiterquerschnitt Generator bis Sturmabschaltung	mm <sup>2</sup>	
5.08	Kabellänge DC Sturmabschaltung bis Wechselrichter	m	
5.09	Leiterquerschnitt Sturmabsch. bis Wechselrichter	mm <sup>2</sup>	
5.10	Kabellänge DC gesamt:	m	
5.11	Unterschiedliche Querschnitte (DC) eingebaut	<input type="radio"/> Ja	<input type="radio"/> Nein
5.12	Wenn ja - welche Querschnitte	mm <sup>2</sup>	
5.13	Wenn ja - Übergänge bei wieviel m	m	
Detaillierten Schaltplan beifügen!			

5.14	Kabellänge AC Wechselrichter bis Anschlusspunkt				m
5.15	Leiterquerschnitt AC				mm <sup>2</sup>
5.16	Fabrikat und Typ AC Kabel				
Detaillierten Schaltplan beifügen!					
5.17	Strommesswert Generator bei Vormontageprüfung				A
5.18	Bei Spannung				V
5.19	Prüfung durchgeführt am				
5.20	Sicherung/Bauteile DC eingebaut	<input type="radio"/>	Ja	<input type="radio"/>	Nein
5.21	Fabrikat & Typ Bauteile				
5.22	Sicherung/Bauteile AC eingebaut	<input type="radio"/>	Ja	<input type="radio"/>	Nein
5.23	Fabrikat & Typ Bauteile				
5.24	Scheinleistung gesamte AC-Anlage im Stand-By				VA
5.25	Wirkleistung gesamte AC-Anlage im Stand-By				W
5.26	Kennlinie bei Inbetriebnahme				
5.27	Kennlinie aktuell				
Datierte Fotos der Bildschirme mit Kennlinien und Einstellungen beifügen!					
5.28	Sturmabschaltung korrekt eingerichtet	<input type="radio"/>	Ja	<input type="radio"/>	Nein
Datierte Fotos der Bauteile mit gesetzten Einstellungen beifügen!					
5.29	Schalleinstellung eingebaut	<input type="radio"/>	Ja	<input type="radio"/>	Nein

### Teilbereich VI - Montage Gondel & Rotorblatt

6.01	Tag der Montage				
6.02	Außentemperatur bei Montage				
6.03	Wind am Montagetag				km/h

6.04	Regen am Montagetag	<input type="radio"/>	Ja	<input type="radio"/>	Nein
6.05	Schutzwachs an der Gondel verwendet	<input type="radio"/>	Ja	<input type="radio"/>	Nein
6.06	Falls ja - welcher Typ Wachs				
6.07	Rotor am Boden oder auf Mast montiert	<input type="radio"/>	Am Boden	<input type="radio"/>	Auf Mast
6.08	Rotor am Boden vormontiert	<input type="radio"/>	Ja	<input type="radio"/>	Nein
6.09	Schraubensicherungskleber verwendet	<input type="radio"/>	Ja	<input type="radio"/>	Nein
6.10	Fabrikat und Typ Schraubensicherungskleber				
6.11	An diesen Stellen wurde Kleber aufgetragen				
Fotos beifügen!					
6.12	Fabrikat & Typ Drehmomentschlüssels für Rotormontage				
6.13	Einstellbereich des Drehmomentschlüssels				
6.14	Messtoleranz des Drehmomentschlüssels				
6.15	Eingestelltes Drehmoment bei der Montage des Rotors				
Eichzertifikat des Drehmomentschlüssels beifügen!					
6.16	Fabrikat & Typ Drehmomentschlüssels für Gondel				
6.17	Einstellbereich des Drehmomentschlüssels				
6.18	Messtoleranz des Drehmomentschlüssels				
Eichzertifikat des Drehmomentschlüssels beifügen!					
6.19	Fabrikat & Typ Drehmomentschlüssels für Mast				
6.20	Einstellbereich des Drehmomentschlüssels				
6.21	Messtoleranz des Drehmomentschlüssels				
Eichzertifikat des Drehmomentschlüssels beifügen!					
6.22	Fabrikat & Typ Maschinenwasserwaage				

6.23	Messtoleranz der Maschinenwasserwaage				
6.24	Neigungswinkel Gondeldeckel bei lotrechtem Mast			°	
				Dieser Winkel darf -4° bis +4° betragen.	
6.25	Drehmoment der Madenschrauben am Mastadapter				
6.26	Drehmoment der Gondelsicherungsschrauben				
6.27	Rundlauf Mastadapter vor Einbau	<input type="radio"/>	Ja	<input type="radio"/>	Nein
6.28	Fett in der Gondel verwendet	<input type="radio"/>	Ja	<input type="radio"/>	Nein
6.29	Wenn ja - welcher Typ				
6.30	Gewicht Rotorblatt 1 & 2				g
6.31	Kabel-Zugentlastung in der Gondel	<input type="radio"/>	Ja	<input type="radio"/>	Nein
6.32	Wie durchgeführt				
6.33	Fabrikat & Typ Zugentlastung				
6.34	Verbindungstyp für Generatorkabel an DC-Kabel in der Gondel:				
6.35	Fabrikat & Typ Verbindungsmittel				

### Teilbereich VII - Inbetriebnahme und Prüfung

7.01	Tag der Inbetriebnahme				
7.02	Vollständigen Inbetriebnahmetest durchgeführt	<input type="radio"/>	Ja	<input type="radio"/>	Nein
7.03	Anlage läuft bei Test gleichmäßig und leise	<input type="radio"/>	Ja	<input type="radio"/>	Nein
7.04	Anlage speist bei Test Leistung wie vorgesehen ein	<input type="radio"/>	Ja	<input type="radio"/>	Nein
7.05	Hauptschalter bremst Anlage sofort	<input type="radio"/>	Ja	<input type="radio"/>	Nein
7.06	Einlaufphase abgeschlossen (50 Produktionsstunden)	<input type="radio"/>	Ja	<input type="radio"/>	Nein
7.07	Fabrikat & Typ Labornetzteil				

7.08	Fabrikat & Typ Multimeter	
7.09	Strom bei 5 V am DC Eingang des Wechselrichters	
7.10	Strom bei 15 V am DC Eingang des Wechselrichters	
7.11	Zeit von 25 V bis Rotorstillstand bei Auslösung Hauptschalter	Sekunden
7.12	Zeit von 0 bis 20 V bei 5 A am DC-Eingang des Wechselrichters	Sekunden
7.13	Derzeit sicher außer Betrieb genommen	<input type="radio"/> Ja <input type="radio"/> Nein
7.14	Wann	

### Anlage fertig installiert & in Betrieb genommen

8.01	Ort, Datum Planer*	
8.02	Unterschrift Planer*	
*Wenn vorhanden		
8.03	Ort, Datum Monteur	
8.04	Unterschrift Monteur	
8.05	Ort, Datum Elektriker	
8.06	Unterschrift Elektriker	
8.07	Ort, Datum Betreiber	
8.08	Unterschrift Betreiber	

Bildformat 9 x 13

Ansicht Ihrer SkyWind Anlage mit Blick nach **NORDEN**.

Das Foto muss mindestens Ihre Anlage, den gesamten Mast und den Hintergrund zeigen.

Ihre Bemerkungen:

Bildformat 9 x 13

Ansicht Ihrer SkyWind Anlage mit Blick nach **WESTEN**.

Das Foto muss mindestens Ihre Anlage, den gesamten Mast und den Hintergrund zeigen.

Ihre Bemerkungen:

Bildformat 9 x 13

Ansicht Ihrer SkyWind Anlage mit Blick nach **SÜDEN**.

Das Foto muss mindestens Ihre Anlage, den gesamten Mast und den Hintergrund zeigen.

Ihre Bemerkungen:

Bildformat 9 x 13

Ansicht Ihrer SkyWind Anlage mit Blick nach **OSTEN**.

Das Foto muss mindestens Ihre Anlage, den gesamten Mast und den Hintergrund zeigen.

Ihre Bemerkungen:

Bildformat 9 x 13

Foto des Wechselrichters mit Bremslast

Das Foto muss den Wechselrichter im fertig montierten betriebsbereiten Zustand zeigen.

Ihre Bemerkungen:

Bildformat 9 x 13

Foto der Sturmabschaltung

Das Foto muss Ihre fertig montierte Sturmabschaltung an der Wand zeigen.

Ihre Bemerkungen:



Bildformat 9 x 13

Foto der Einstellungen des Wechselrichters nach der Inbetriebnahme.

Das Foto darf nicht während der Einstellung aufgenommen werden, sondern erst später bei Inbetriebnahme.

Ihre Bemerkungen:

Bildformat 9 x 13

Foto der Einstellungen der Sturmabschaltung.

Das Foto muss alle Einstellungen der Sturmabschaltungsrelais bei Inbetriebnahme zeigen.

Ihre Bemerkungen:

Bildformat 9 x 13

Foto der Rotormontage

Foto muss den Rotor, den Rotormontagekonus und die Befestigungsschraube sowie das Loctite zeigen.

Ihre Bemerkungen:

Bildformat 9 x 13

#### Foto Wasserwaage Position 1

Legen Sie die Wasserwaage senkrecht an den Masten an.

Ihre Bemerkungen:

Bildformat 9 x 13

#### Foto Wasserwaage Position 2

Legen Sie die Wasserwaage 90° versetzt senkrecht an den Masten an.

Ihre Bemerkungen:

Bildformat 9 x 13

#### Foto des Mastfußes

Das Foto zeigt das Fundament (bei freistehenden Masten) oder den Montagefuß des Mastsystems in montiertem Zustand.

Ihre Bemerkungen:

Bildformat 9 x 13

**Foto Entkopplung (sofern vorhanden)**  
Das Foto zeigt die Entkopplung bzw. die montierten Entkoppler des Masten.

Ihre Bemerkungen:

Bildformat 9 x 13

**Foto Abspannung (sofern vorhanden)**  
Das Foto zeigt die Abspannung des Masten. Unzulässig bei SkyWind Aufdach- und Flanschmastsystemen.

Ihre Bemerkungen:

Bildformat 9 x 13

**Foto Anlagentest bei 25 V**  
Das Foto zeigt das Leistungsdisplay des Wechselrichters im Inbetriebnahmetest bei 25 V.

Ihre Bemerkungen:

Bildformat 9 x 13

Foto Ihrer Schalleinstellung (sofern vorhanden)

Das Foto zeigt die Einstellungen der optional eingebauten Schalleinstellung.

Ihre Bemerkungen:

Bildformat 9 x 13

Foto 1

Platz für Ihre Anlagendetails.

Ihre Bemerkungen:

Bildformat 9 x 13

Foto 2

Platz für Ihre Anlagendetails.

Ihre Bemerkungen:

Bildformat 9 x 13

Foto 3

Platz für Ihre Anlagendetails.

Ihre Bemerkungen:

Bildformat 9 x 13

Foto 4

Platz für Ihre Anlagendetails.

Ihre Bemerkungen:

Bildformat 9 x 13

Foto 5

Platz für Ihre Anlagendetails.

Ihre Bemerkungen:

Bildformat 9 x 13

Foto 6

Platz für Ihre Anlagendetails.

Ihre Bemerkungen:

Bildformat 9 x 13

Foto 7

Platz für Ihre Anlagendetails.

Ihre Bemerkungen:

Bildformat 9 x 13

Foto 8

Platz für Ihre Anlagendetails.

Ihre Bemerkungen:

## Schaltplan der tatsächlichen Anlage

Schaltbild einkleben oder aufzeichnen lassen

## Beschreibung Ihrer Gesamtanlage

Notieren Sie ggf. Batteriespeicher, PV-Anlagen, BHKW, Wärmepumpen etc.  
und wie diese gekoppelt sind.



## Inspektionsprotokoll Stürme

Sturm Nr.	Datum Sturm	Datum Überprüfung	Überprüft durch	Schäden festgestellt	Behoben durch
1					
2					
3					
4					
5					
6					
7					
8					
9					
10					
11					
12					
13					
14					
15					
16					
17					
18					
19					
20					

Hinweis: Stürme liegen ab Überschreitung von Windstärke 8 vor. Jeder Sturm ist zu erfassen. Legen Sie Ihrem Protokollbuch ggf. ausgedruckte Nachweise (Wetterwarnung etc.) bei. Auch eine etwaige Versicherung wird diese ggf. für die Regulierung benötigen.

## Inspektionsprotokoll Stürme

Sturm Nr.	Datum Sturm	Datum Überprüfung	Überprüft durch	Schäden festgestellt	Behoben durch
21					
22					
23					
24					
25					
26					
27					
28					
29					
30					
31					
32					
33					
34					
35					
36					
37					
38					
39					
40					

Hinweis: Stürme liegen ab Überschreitung von Windstärke 8 vor. Jeder Sturm ist zu erfassen. Legen Sie Ihrem Protokollbuch ggf. ausgedruckte Nachweise (Wetterwarnung etc.) bei. Diese wird Ihre Versicherung ggf. für die Regulierung benötigen.

## Inspektionsprotokoll 5-Jahres-Inspektion

Inspektion	Datum	Betrieb	Befund	Behoben	Unterschrift Betrieb
5 Jahre nach Installation					
10 Jahre nach Installation					
15 Jahre nach Installation					
20 Jahre nach Installation					
25 Jahre nach Installation					
Außerbetriebsetzung					

Die Inspektion ist durch geschultes Personal durchzuführen. Sollte es zu Beschädigungen gekommen sein sind diese zu vermerken und die Behebung durch den Betrieb zu quittieren. Die Inspektion muss alle funktionalen Teile der Anlage erfassen, dies betrifft gem. DIN mindestens: Rotorblätter, Ableitkabel (insb. Verdrillung), Abspannseile (wenn vorhanden), sämtliche Befestigungselemente.

## Protokoll sonstiger Eingriffe/Vorkommnisse

Vorkommnis	Datum

Halten Sie hier auch besondere Ereignisse wie Umbauten oder sonstige Arbeiten an der Anlage fest. Auch Vorkommen die Einfluss auf die Anlage haben könnten, wie etwa eine Neueindeckung des Dachs, Umlegen des Masten etc. sollten hier vermerkt werden.



SkyWind NG  
Next Generation Windpower